



**CRUCE DE REFERENCIAS**

**2014**



 CAHSAENEJH

 ENEJH

 @grupo\_enejh

[www.enejh.com](http://www.enejh.com)

[pedidos@enejh.com](mailto:pedidos@enejh.com)

TEL: +52(55) 5362 6270

LADA SIN COSTO: 01800 0036 354

FAX: +52(55) 5365 76 27



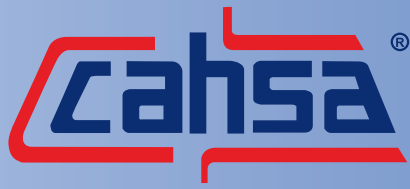

## Cables para bujías /Ignition Set

### EPDM

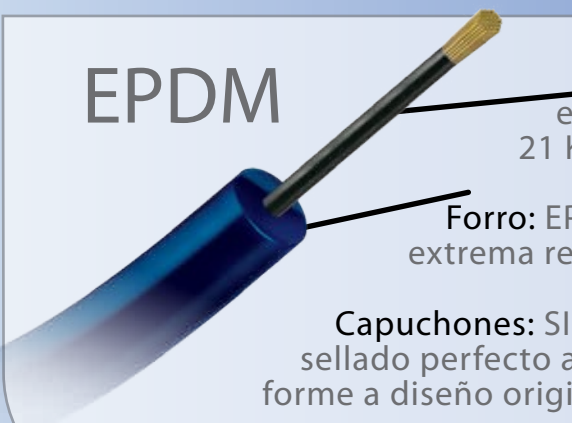

**Conductor:** Núcleo Grafitado supresor de interferencia electromagnética (EMI) con resistencia de 9 a 21 Kohms por metro.

**Forro:** EPDM ANTIFLAMA de 8 mm, altamente dieléctrico, extrema resistencia al Aceite, Grasas, Ozono.

**Capuchones:** SILICÓN ANTIFLAMA, altamente dieléctrico, aislante y sellado perfecto al cable, a prueba de humedad y temperatura, conforme a diseño original.

### SILICÓN



**Conductor:** Núcleo Grafitado supresor de interferencia electromagnética (EMI) con resistencia de 9 a 21 Kohms por metro.

**Forro TRICAPA:** SILICON ANTIFLAMA de alta temperatura 7 y 8 mm, malla de fibra de vidrio, centro aislante de EPDM altamente dieléctrico.

**Capuchones:** SILICÓN ANTIFLAMA, altamente dieléctrico, aislante y sellado perfecto al cable, a prueba de humedad y temperatura, conforme a diseño original.

### golden

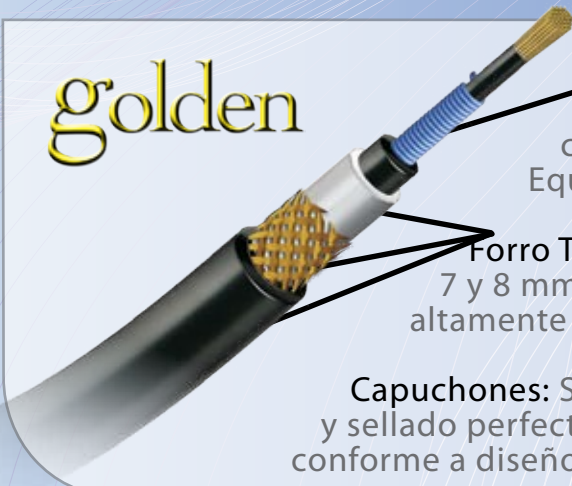

**Conductor:** Bobinado (wire wound) reparte máximo voltaje sin interferencia de radio frecuencia (IRF) y cumple con la resistencia especificada en Equipo Original.

**Forro TRICAPA:** SILICON ANTIFLAMA de alta temperatura 7 y 8 mm, malla de fibra de vidrio, centro aislante de EPDM altamente dieléctrico.

**Capuchones:** SILICÓN ANTIFLAMA, altamente dieléctrico, aislante y sellado perfecto al cable, a prueba de humedad y temperatura, conforme a diseño original.





# CAHSA vs BERU

		BERU			BERU			BERU
VW043	B5946W4	056 998 031 Z+B	FO0212	B59378F4	533F8	GM0172	B6998G4	815G4
FO0152	B6978F8	1203aF8	GM028	B5740G6	533G6	HN011	B69117HN4	815H4
CH040	B6703C8	1270aC8	GM0197	B59163G6	533G6	FO0160	B69105F4	816F4
MIO40	B69372MI4	1501MT4	VW028	B5934W4	535W4	FO063	B6718F6	816F6
TY022	B69119Y6	1503Y6	VW091	B5947W4	536W4	GM0164	B6994G6	816G6
TY060	B69363Y4	1513Y4	GM082	B5834G6	537G6VB	FO079	B6751F6	817F6
TY061	B69364Y4	1514Y4	FO0104	B5844F6	541F6	CH037	B6736C6	818C6
TY011	B6932Y4	1515Y4	FO033	B5708F6	542F6	CH097	B69160C6	819C6
HN01981	B1981HN6	301H6	CH024	B5703C8	543C8	FO0148	B6976F6	819F6
NIO1537	B1537N4	301N4	FO023	B5746F4	546F4	GM0136	B6952G6	819G6
GM019127	B19127G4	301S4	FO024	B5747F8	547F8VB	FO0136	B6950F6	822F6
HN01814	B1814HN4	302H4	FO025	B5748F6	548F6	GM0162	B6993G6	822G6
CH019304	B19304C4	302HY4	FO026	B5749F8	549F8	FO0164	B69112F6	825F6
NIO19115	B19115N6	302N6	FO018	B5780F4	552F4	FO0164	B69112F6	826F6
HN01979	B1979HN4	303H4	ES002	B5760FG8	560FyG8	FO0199	B69235F6	828F6
HY019102	B19102HY4	303HY4	RE016	B5380R4	560R4	FO0162	B69106F6	829F6
NIO60	B6533N4	303N4	ES003	B5770FG8	570FyG8	NIO25	B6531N4	831N4
NIO19225	B19225N6	304N6	FO0188	B59169F6	586F6	CH027	B6333C4	833C4
NIO1982	B1982N4	306N4	VW062	B6934W4	5A2/1.8	CH029	B6334C4	834C4
NIO1233	B1233N4	307N4	VW037	B6354W4	5A3/2.0	FO081	B6754F4	834F4
NIO19114	B19114N6	307N6VB	VW034	B5354W4	5A3/2.0VB	FO0156	B6991F4	835F4
FO019129	B19129F6	307N6VB	VW033	B5353W4	5CAR85	FO067	B6757F6	836F6
GM01954	B1954G8	309G8	VW032	B5352W4	5SED92	CH038	B6743C6	837C6
NIO19360	B19360N6	310N6	VW045	B8352W4	5SED92VB	GM060	B6729G4	838G4
GM01954	B1954G8	315G8	VW069	B6947W4	5SED94	GM089	B6911G4	838G4
GM01941	B1941G6	318G6	FO0214	B69377F4	801F4	FT010	B69357FT4	838G4
GM01917	B1917G8	320G8	CH071	B6825C6	802C6	CH068	B6543C4	843C4
GM019221	B19221G6	321G6	CH044	B6782C8	802C8	FO0182	B69138F6	844F6
GM01941	B1941G6	370G6	FO0132	B6948F4	802F4	CH069	B6820C6	847C6
FO058	B5769F8	501F8	MZ028	B69232MZ6	802M6	CH085	B6987C6	848C6
MZ010	B5832MZ4	501M4	GM0103	B69236C8	803C8	GM0132	B6828G4	854G4
FO088	B5827F6	502F6	FO0152	B6978F8	803F8	GM0206	B69167G4	860G4
GM0279	B59359G3	502G3	CH054	B6908C6	804C6	CH064	B6965C4	861C4
TY002	B5722Y4	502Y4	GM0184	B69136G4	804G4	FO070	B6725F8	861F8
MIO11	B59121M6	503MT6	HY009	B6778HY4	804HY4	GM0196	B69161G4	861G4
FO090	B5833F4	504F4	CH019	B6791C6	805C6	HY006	B6779HY4	862C4
GM053	B5719G6	504G6	FO0115	B6937F4	805F4	FO0146	B6975F6	865F6
FO086	B5815F8	505F8	CH081	B6985C6	806C6	FO0142	B6973F6	868F6
TY008	B5822Y6	505Y6	GM0130	B6282G4	806G4	FO0197	B69222F6	869F6
FO089	B5831F6	506F6	FO092	B6912F4	807F4	CH040	B6703C8	870C8
MZ003	B5759MZ4	506M4	FO0213	B69378F4	807F4	GM0204	B69166G4	881G4
ES008	B5813FG8	509U8	FO065	B6734F6	807F6	FO0101	B6836F6	883F6
GM078	B5829G6	510G6	FO094	B6913F4	808F4	FO0146	B6975F6	883F6
GM0177	B59109G6	511U6	ES009	B6813FG8	808F8	FO0144	B6974F6	884F6
FO031	B5706F8	514F8	DW017	B69104D4	808G4	FO0187	B69168F6	885F6
FO0129	B6831F6	516aF6	GM064	B6726G6	808G6	FO0191	B69170F6	887F6
CH013	B5300C6	520C6	CH089	B69107C4	809C4	FO0201	B69234F8	889F8
CH015	B5790C8	520C8	FO0144	B6974F6	809F6	GM0104	B6846G6	891G6
NIO13	B5230N4	520N4VB	GM0194	B69159G4	809G4	NIO35	B6233N4	B6233N4
RE014	B5240R4	520R4	GM0260	B69270G6	809G6	CH089	B69107C4	BE 1209aC4
NIO11	B5400N4	520T4VB	CH064	B6965C4	810C4	CH064	B6965C4	BE 1210aC4
VA005	B5250V6	520V6	FO079	B6751F6	810F6	CH055	B5842C6	BE 1222C6
CH014	B5301C6	521C6VB	GM0236	B69228G8	810G8	CH064	B6965C4	BE 1261aC4
RE015	B5370R4	521R4	FO0101	B6836F6	811F6	FO0214	B69377F4	BE 1201aF4
TY001	B5721Y4	521Y4	FO059	B6737F4	812F4	HY009	B6778HY4	BE 1201aHY4
CH055	B5842C6	522C6	FO0129	B6831F6	812F6	MZ030	B69267MZ6	BE 1201aM6
FO016	B5290F8	522F8	FO0138	B6951F6	813F6	NIO1537	B1537N4	BE 1201cN4
NIO18	B5402N4	522T4VB	GM0132	B6828G4	813G4	GM019127	B19127G4	BE 1201cS4
FO049	B5761F4	523F4	GM0136	B6952G6	813G6	MIO40	B69372MI4	BE 1201dMT4
NIO16	B5224N4	524N4	HN005	B6980HN4	813H4	MZ010	B5832MZ4	BE 1201M4
RE017	B5524R4	524R4	FO0180	B69135F4	814F4	CH044	B6782C8	BE 1202aC8
GM045	B5713G4	525G4	GM061	B6203G4	814G4	FO0132	B6948F4	BE 1202aF4
CH059	B5857C4	528C4	GM0162	B6993G6	814G6	IS008	B69140I6	BE 1202aH6
CH018	B5791C6	531C6VB	FO0126	B6761F4	814H4	CH019304	B19304C4	BE 1202cHY4
FO027	B5784F8	532F8	FO0127	B6826F4	815F4	NIO19115	B19115N6	BE 1202cN6

**BERU**

TY021	B69116Y6	BE1202dY6
FO088	B5827F6	BE1202F6
GM0279	B59359G3	BE1202G3
TY002	B5722Y4	BE1202Y4
CH0103	B69236C8	BE1203aC8
MZ017	B6794MZ4	BE1203aM4
HY019102	B19102HY4	BE1203cHY4
NIO60	B6533N4	BE1203cN4
TY022	B69119Y6	BE1203dY6
MI011	B59121M6	BE1203MT6
CH054	B6908C6	BE1204aC6
GM0184	B69136G4	BE1204aG4
NIO19225	B19225N6	BE1204cN6
FO090	B5833F4	BE1204F4
FO1115	B6937F4	BE1205aF4
GM0212	B69186G4	BE1205aG4
FO086	B5815F8	BE1205F8
TY008	B5822Y6	BE1205Y6
CH081	B6985C6	BE1206aC6
TY026	B69158Y4	BE1206aY4
NIO1982	B1982N4	BE1206cN4
FO019275	B19275F6	BE1206cN6
FO089	B5831F6	BE1206F6
FO092	B6912F4	BE1207aF4
FO0213	B69378F4	BE1207aF4
FO065	B6734F6	BE1207aF6
CH033	B5843C4	BE1207C4
NIO1233	B1233N4	BE1207cN4
NIO19114	B19114N6	BE1207cN6
FO019129	B19129F6	BE1207cN6
TY063	B69365Y4	BE1207dY4
FO094	B6913F4	BE1208aF4
DW017	B69104D4	BE1208aG4
GM064	B6726G6	BE1208aG6
TY023	B69143Y4	BE1208dY4
FO0144	B6974F6	BE1209aF6
GM01954	B1954G8	BE1209cG8
GM0236	B69228G8	BE1210aG8
HN003	B6979HN4	BE1210aH4
NIO19360	B19360N6	BE1210cN6
TY059	B69362Y4	BE1210dY4
GM078	B5829G6	BE1210G6
FO0101	B6836F6	BE1211aF6
FO059	B6737F4	BE1212aF4
GM0136	B6952G6	BE1213aG6
TY060	B69363Y4	BE1213dY4
FO0180	B69135F4	BE1214aF4
GM0162	B6993G6	BE1214aG6
FO0126	B6761F4	BE1214aH4
TY061	B69364Y4	BE1214dY4
HN011	B69117HN4	BE1215aH4
GM01954	B1954G8	BE1215cG8
TY011	B6932Y4	BE1215dY4
FO0160	B69105F4	BE1216aF4

**BERU**

FO063	B6718F6	BE1216aF6
GM0164	B6994G6	BE1216aG6
FO079	B6751F6	BE1217aF6
GM0232	B69230G8	BE1217aG8
GM01952	B1952G6	BE1217cG6
CH037	B6736C6	BE1218aC6
GM01941	B1941G6	BE1218cG6
FO0148	B6976F6	BE1219aF6
GM0136	B6952G6	BE1219aG6
FO079	B6751F6	BE1220aF6
CH013	B5300C6	BE1220C6
CH015	B5790C8	BE1220C8
NIO13	B5230N4	BE1220N4
NIO11	B5400N4	BE1220T4
VA005	B5250V6	BE1220V6
CH014	B5301C6	BE1221C6
GM019221	B19221G6	BE1221cG6
FO016	B5290F8	BE1221F8
TY001	B5721Y4	BE1221Y4
GM0162	B6993G6	BE1222aG6
NIO18	B5402N4	BE1224T4
FO0164	B69112F6	BE1225aF6
FO0164	B69112F6	BE1226aF6
FO0162	B69106F6	BE1229aF6
NIO25	B6531N4	BE1231aN4
CH018	B5791C6	BE1231C6
FO027	B5784F8	BE1232F8
CH027	B6333C4	BE1233aC4
NIO35	B6233N4	BE1233aN4
GM028	B5740G6	BE1233G6
GM0197	B59163G6	BE1233G6
CH029	B6334C4	BE1234aC4
FO081	B6754F4	BE1234aF4
FO0156	B6991F4	BE1235aF4
CH038	B6743C6	BE1237aC6
GM086	B6834G6	BE1237aG6
NIO33	B5530N4	BE1237cN4
GM060	B6729G4	BE1238aG4
GM089	B6911G4	BE1238aG4
FT010	B69357FT4	BE1238aG4
NIO19100	B19100N4	BE1238cN4
FO0104	B5844F6	BE1241F6
FO033	B5708F6	BE1242F6
CH068	B6543C4	BE1243aC4
NIO77	B69276N4	BE1243aN4
CH024	B5703C8	BE1243C8
CH067	B6970C6	BE1245aC6
FO023	B5746F4	BE1246F4
CH069	B6820C6	BE1247aC6
FO024	B5747F8	BE1247F8
CH085	B6987C6	BE1248aC6
FO026	B5749F8	BE1249F8
FO018	B5780F4	BE1252F4
GM0132	B6828G4	BE1254G4

**BERU**







FO0154	B6990F4	BE1260aF4
GM0206	B69167G4	BE1260aG4
ES002	B5760FG8	BE1260FYG8
FO0210	B69369F4	BE1261aF4
FO0129	B6831F6	BE1261aF6
FO070	B6725F8	BE1261aF8
GM0196	B69161G4	BE1261aG4
GM01954	B1954G8	BE1261cG8
HY006	B6779HY4	BE1262cC4
FO073	B6739F8	BE1263aF8
FO0107	B6852F4	BE1265aF4
GM01957	B1957G8	BE1266cG8
FO0158	B6992F6	BE1267aF6
FO0142	B6973F6	BE1268aF6
GM0214	B69189G8	BE1268aG8
FO0197	B69222F6	BE1269aF6
GM019221	B19221G6	BE1269cG6
CH053	B6907C4	BE1270aC4
SN002	B69185SN4	BE1270aG4
GM01941	B1941G6	BE1270cG6
ES003	B5770FG8	BE1270FYG8
CH087	B6988C4	BE1272aC4
GM0276	B69325G4	BE1275aG4
FO0175	B59132F6	BE1275F6
FO0158	B6992F6	BE1276aF6
GM0110	B6856G6	BE1279aG6
GM0204	B69166G4	BE1281aG4
FO0101	B6836F6	BE1283aF6
FO0146	B6975F6	BE1283aF6
FO0144	B6974F6	BE1284aF6
FO0187	B69168F6	BE1285aF6
FO0188	B59169F6	BE1286F6
FO0191	B69170F6	BE1287aF6
FO0201	B69234F8	BE1289aF8
GM0108	B6851G6	BE1289aG6
GM0104	B6846G6	BE1291aG6
GM01917	B1917G8	BE800V8G8
ST002	B6938ST4	IBIZA01/05
ST001	B5938ST4	IBIZA01/05VB
VW050	B6962W4	NBA4
VW049	B5962W4	NBA4VB
VW064	B6936W4	POINTER
VW070	B59149W4	POINTER05VB
VW040	B5936W4	POINTERVB
VW067	B69113W4	POLO02
VW066	B59113W4	POL002VB
VW071	B69149W4	PONTER05
VW042	B6945W6	VR6
VW095	B59361W6	VR6/00
VW052	B5945W6	VR6VB
RE030	B69220R4	ZEF1612
FT011	B69370FT4	ZEF983
VW092	B69371W4	ZEF991



\* Toda la información incluida en esta publicación, ha sido obtenida por fuentes confiables y oficiales, consideramos y aceptamos toda responsabilidad por errores, omisiones o cualquier otro resultado de esta información.









# CAHSA vs BOSCH

		BOSCH			BOSCH			BOSCH
VW032	B5352W4	0986MG0102	RE016	B5380R4	0986MG0504	NI018	B5402N4	0986MG0816
VW035	B5355W4	0986MG0103	RE017	B5524R4	0986MG0505	NI035	B6233N4	0986MG0817
VW003	B8342W4	0986MG0104	TY001	B5721Y4	0986MG0506	GM030	B5720G8	0986MG0903
VW091	B5947W4	0986MG0105	TY002	B5722Y4	0986MG0507	GM028	B5740G6	0986MG0905
VW001	B8341W4	0986MG0200	TY004	B5723Y4	0986MG0508	GM033	B5742G4	0986MG0911
VW026	B5762W4	0986MG0202	KI019	B59318K4	0986MG0510	GM060	B6729G4	0986MG0912
VW034	B5354W4	0986MG0300	MZO19232	B19232MZ6	0986MG0511	GM039	B6731G8	0986MG0916
VW040	B5936W4	0986MG0302	MC019142	B19142MC4	0986MG0512	GM0136	B6952G6	0986MG0922
VW052	B5945W6	0986MG0303	CH012	B5750C4	0986MG0601	GM045	B5713G4	0986MG0924
VW049	B5962W4	0986MG0307	CH013	B5300C6	0986MG0602	GM042	B5704G4	0986MG0926
VW066	B59113W4	0986MG0308	CH015	B5790C8	0986MG0603	GM053	B5719G6	0986MG0927
VW070	B59149W4	0986MG0309	CH029	B6334C4	0986MG0606	GM036	B5534G8	0986MG0928
VW038	B5357W5	0986MG0310	CH027	B6333C4	0986MG0607	GM030	B5720G8	0986MG0929
VW034	B5354W4	0986MG0311	CH046	B6783C6	0986MG0608	GM035	B5756G8	0986MG0930
FO015	B5200F8	0986MG0401	CH071	B6825C6	0986MG0609	GM0143	B5956G8	0986MG0931
FO0104	B5844F6	0986MG0402	CH031	B5736C6	0986MG0610	GM044	B5715G6	0986MG0932
FO018	B5780F4	0986MG0404	CH054	B6908C6	0986MG0611	GM083	B5835G8	0986MG0933
FO045	B5735F6	0986MG0413	CH064	B6965C4	0986MG0612	GM0236	B69228G8	0986MG0934
FO022	B5744F8	0986MG0414	HY006	B6779HY4	0986MG0613	GM0136	B6952G6	0986MG0935
FO0111	B6855F8	0986MG0417	CH033	B5843C4	0986MG0619	GM0232	B69230G8	0986MG0936
FO042	B5716F8	0986MG0421	CH014	B5301C6	0986MG0620	GM064	B6726G6	0986MG0937
FO023	B5746F4	0986MG0423	CH022	B5753C4	0986MG0622	GM0170	B6997G8	0986MG0938
FO079	B6751F6	0986MG0425	CH032	B5767C4	0986MG0623	GM0230	B69229G8	0986MG0939
FO094	B6913F4	0986MG0426	CH017	B5543C4	0986MG0624	GM0164	B6994G6	0986MG0940
FO065	B6734F6	0986MG0428	CH018	B5791C6	0986MG0625	GM0132	B6828G4	0986MG0941
FO079	B6751F6	0986MG0430	CH076	B5984C8	0986MG0626	GM0136	B6952G6	0986MG0942
FO0127	B6826F4	0986MG0431	CH038	B6743C6	0986MG0629	GM016	B6270G6	0986MG0943
FO088	B5827F6	0986MG0432	CH064	B6965C4	0986MG0630	GM085	B6830G4	0986MG0944
FO0101	B6836F6	0986MG0433	CH053	B6907C4	0986MG0631	GM020	B6710G6	0986MG0945
FO032	B5707F6	0986MG0435	CH01703	B1703C8	0986MG0632	GM020	B6710G6	0986MG0946
FO081	B6754F4	0986MG0436	HY002	B5778HY4	0986MG0633	GM0150	B6964G4	0986MG0947
FO051	B5763F8	0986MG0438	CH025	B5712C4	0986MG0634	GM0132	B6828G4	0986MG0948
FO076	B6716F8	0986MG0439	CH063	B5965C4	0986MG0635	GM061	B6203G4	0986MG0949
FO026	B5749F8	0986MG0440	CH01985	B1985C6	0986MG0636	GM023	B6741G6	0986MG0950
ES008	B5813FG8	0986MG0441	CH019236	B19236C8	0986MG0637	GM0120	B6927G4	0986MG0951
FO034	B5714F4	0986MG0442	HNO1979	B1979HN4	0986MG0701	GM0162	B6993G6	0986MG0952
FO0137	B5951F6	0986MG0443	HNO1980	B1980HN4	0986MG0702	GM059	B6534G8	0986MG0954
FO030	B5705F8	0986MG0444	NI01531	B1531N4	0986MG0703	GM022	B6730G8	0986MG0955
FO088	B5827F6	0986MG0445	NI075	B69225N6	0986MG0704	GM01544	B1544G8	0986MG0956
FO048	B5739F8	0986MG0446	VW056	B6355W4	0986MG0705	GM099	B6544G8	0986MG0957
FO084	B5809F8	0986MG0447	VW037	B6354W4	0986MG0706	GM0234	B69231G8	0986MG0958
FO089	B5831F6	0986MG0448	VW050	B6962W4	0986MG0707	GM0110	B6856G6	0986MG0959
FO033	B5708F6	0986MG0449	VW064	B6936W4	0986MG0708	GM0193	B59159G4	0986MG0960
FO086	B5815F8	0986MG0450	VW042	B6945W6	0986MG0709	GM01952	B1952G6	0986MG0961
FO044	B5734F6	0986MG0451	VW077	B69223W4	0986MG0710	GM0211	B59186G4	0986MG0962
FO025	B5748F6	0986MG0452	FO094	B6913F4	0986MG0712	GM01952	B1952G6	0986MG0964
FO040	B5601F6	0986MG0453	FO087	B6815F8	0986MG0713	GM0205	B59167G4	0986MG0965
FO058	B5769F8	0986MG0454	FO0144	B6974F6	0986MG0715	GM0275	B59325G4	0986MG0966
FO030	B5705F8	0986MG0455	FO063	B6718F6	0986MG0717	GM0193	B59159G4	0986MG0967
FO040	B5601F6	0986MG0456	CH064	B6965C4	0986MG0718	DW016	B59104D4	0986MG0968
FO047	B5738F6	0986MG0457	CH044	B6782C8	0986MG0719			
FO034	B5714F4	0986MG0458	NI025	B6531N4	0986MG0720			
FO031	B5706F8	0986MG0459	NI052	B6982N4	0986MG0721			
FO090	B5833F4	0986MG0460	GM096	B6916G6	0986MG0722			
FO054	B5724F8	0986MG0461	GM039	B6731G8	0986MG0723			
FO038	B6701F6	0986MG0463	GM098	B6917G8	0986MG0724			
FO067	B6757F6	0986MG0464	NI01233	B1233N4	0986MG0725			
FO059	B6737F4	0986MG0465	NI019115	B19115N6	0986MG0726			
FO0132	B6948F4	0986MG0466	GM01952	B1952G6	0986MG0727			
FO081	B6754F4	0986MG0468	GM01928	B1928G8	0986MG0728			
FO092	B6912F4	0986MG0470	GM01917	B1917G8	0986MG0729			
FO0115	B6937F4	0986MG0471	GM01954	B1954G8	0986MG0731			
FO088	B5827F6	0986MG0472	GM019127	B19127G4	0986MG0732			
FO066	B6735F6	0986MG0473	GM01972	B1972G4	0986MG0733			
FO073	B6739F8	0986MG0474	HNO1979	B1979HN4	0986MG0734			
FO0143	B5974F6	0986MG0475	HNO1981	B1981HN6	0986MG0735			
FO0145	B5975F6	0986MG0476	MI016	B69141M6	0986MG0736			
FO019106	B19106F6	0986MG0477	TY022	B69119Y6	0986MG0738			
FO019105	B19105F4	0986MG0478	TY021	B69116Y6	0986MG0739			
FO046	B5737F4	0986MG0479	GM01952	B1952G6	0986MG0740			
VA005	B5250V6	0986MG0500	NI011	B5400N4	0986MG0801			
MZ010	B5832MZ4	0986MG0501	NI012	B5220N4	0986MG0811			
RE014	B5240R4	0986MG0502	NI016	B5224N4	0986MG0814			
RE015	B5370R4	0986MG0503	NI019	B5231N8	0986MG0815			



\*Importante: La información indicada en esta publicación, ha sido obtenida por fuentes confiables y oficiales, consideramos que es correcta, sin embargo no asumimos ninguna responsabilidad por errores, cambios, omisiones o datos que resultaron de estos.

# CAHSA vs GARLO

		GARLO			GARLO			GARLO
GM016	B6270G6	8HY-101CON	GM031	B5730G8	JG-132	GM023	B6741G6	HY-151
GM020	B6710G6	8HY-101ELE	GM01720	B1720G8	SEL-132ELE	GM01741	B1741G6	SHY-151
GM025	B5270G6	8JG-101CON	GM01730	B1730G8	SHY-132CON	FO097	B6708F6	8HY-152
GM029	B5710G6	EL-101ELE	NI009	B6230N4	8HY-134	FO033	B5708F6	EL-152
GM016	B6270G6	HY-101	NI013	B5230N4	8JG-134	FO01708	B1708F6	SEL-152
GM025	B5270G6	JG-101	NI013	B5230N4	C-134	VW054	B6352W4	8HY-153
GM01270	B1270G6	SEL-101CON	NI009	B6230N4	HY-134	VW032	B5352W4	8JG-153
GM01710	B1710G6	SEL-101ELE	NI013	B5230N4	JG-134	VW054	B6352W4	HY-153
GM01270	B1270G6	SHY-101	NI01230	B1230N4	SHY-134	VW032	B5352W4	JG-153
FO010	B6200F8	8HY-106	CH009	B6300C6	8HY-135	VW060	B6795W4	8HY-154
FO015	B5200F8	8JG-106	CH013	B5300C6	8JG-135	VW017	B5795W4	8JG-154
FO010	B6200F8	HY-106	CH013	B5300C6	C-135	VW060	B6795W4	HY-154
FO015	B5200F8	JG-106	CH009	B6300C6	HY-135	VW017	B5795W4	JG-154
FO01200	B1200F8	SHY-106	CH013	B5300C6	JG-135	VW01795	B1795W4	SHY-154
FO012	B6350F8	8HY-108	CH01300	B1300C6	SHY-135	NI035	B6233N4	8HY-155
FO017	B5350F8	8JG-108	GM051	B6281G8	8HY-136	NI017	B5233N4	8JG-155
FO012	B6350F8	HY-108	GM027	B5281G8	8JG-136	NI035	B6233N4	HY-155
FO017	B5350F8	JG-108	GM027	B5281G8	C-136	NI017	B5233N4	JG-155
FO01350	B1350F8	SHY-108	GM051	B6281G8	HY-136	NI01233	B1233N4	SHY-155
FO011	B6290F8	8HY-109	GM027	B5281G8	JG-136	NI010	B6400N4	8HY-156
FO016	B5290F8	8JG-109	GM01281	B1281G8	SHY-136	NI011	B5400N4	8JG-156
FO016	B5290F8	C-109	VW013	B6360W4	8HY-137	NI011	B5400N4	C-156
FO011	B6290F8	HY-109	VW016	B5360W4	8JG-137	NI010	B6400N4	HY-156
FO016	B5290F8	JG-109	VW013	B6360W4	HY-137	NI011	B5400N4	JG-156
FO01290	B1290F8	SEL-109	VW016	B5360W4	JG-137	NI01400	B1400N4	SHY-156
FO01290	B1290F8	SHY-109	VW01360	B1360W4	SHY-137	GM099	B6544G8	8HY-157
CH010	B6301C6	8HY-110	RE023	B6370R4	8HY-138	GM037	B5544G8	EL-157
CH014	B5301C6	8JG-110	RE015	B5370R4	8JG-138	GM01544	B1544G8	SEL-157
CH014	B5301C6	C-110	RE023	B6370R4	HY-137	CH035	B6712C4	8HY-158
CH010	B6301C6	HY-110	RE015	B5370R4	JG-137	CH035	B6712C4	HY-158
CH014	B5301C6	JG-110	RE01370	B1370R4	SHY-138	CH01712	B1712C4	SHY-158
CH01301	B1301C6	SHY-110	FO0122	B6706F8	8HY-140ELE	FO075	B6763F8	8HY-160
CH011	B6790C8	8HY-111	FO031	B5706F8	EL-140ELE	FO051	B5763F8	EL-160
CH015	B5790C8	8JG-111	FO01706	B1706F8	SEL-140ELE	FO01763	B1763F8	SEL-160
CH015	B5790C8	C-111	GM019	B6740G6	8HY-141	CH040	B6703C8	HY-161
CH011	B6790C8	HY-111	GM028	B5740G6	EL-141	CH01703	B1703C8	SHY-161
CH015	B5790C8	JG-111	GM01740	B1740G6	SEL-141	FO099	B6746F4	8HY-162
CH01790	B1790C8	SHY-111	CH008	B6750C4	8HY-142	FO023	B5746F4	EL-162
UN023	B5310U4	8JG-112	CH012	B5750C4	8JG-142	FO01746	B1746F4	SEL-162
UN023	B5310U4	C-112	CH008	B6750C4	HY-142	FO0129	B6831F6	8HY-163
UN023	B5310U4	JG-112	CH012	B5750C4	JG-142	FO089	B5831F6	EL-163
UN024	B5320U6	8JG-113	CH01750	B1750C4	SHY-142	FO01831	B1831F6	SEL-163
UN024	B5320U6	C-113	FO0120	B6558F6	8HY-143	FO066	B6735F6	8HY-164
UN024	B5320U6	JG-113	FO028	B5558F6	8JG-143	FO045	B5735F6	EL-164
VA006	B6250V6	8HY-114	FO0120	B6558F6	HY-143	FO01735	B1735F6	SEL-164
VA005	B5250V6	8JG-114	FO028	B5558F6	JG-143	FO076	B6716F8	8HY-165
VA005	B5250V6	C-114	FO01558	B1558F6	SEL-143	FO01716	B1716F8	SEL-165
VA006	B6250V6	HY-114	FO01558	B1558F6	SHY-143	FO0113	B6858F6	8HY-166
VA005	B5250V6	JG-114	FO0105	B6844F6	8HY-144	FO0112	B5858F6	EL-166
VA01250	B1250V6	SHY-114	FO0104	B5844F6	EL-144	FO01858	B1858F6	SEL-166
VW012	B6340W4	8HY-115	FO01844	B1844F6	SEL-144	GM0129	B6545G6	8HY-167
VW015	B5340W4	8JG-115	FO013	B6780F4	8HY-145	GM071	B5545G6	EL-167
VW015	B5340W4	C-115	FO018	B5780F4	EL-145	GM01545	B1545G6	SEL-167
VW012	B6340W4	HY-115	FO01780	B1780F4	SEL-145	GM062	B6719G6	8HY-168
VW015	B5340W4	JG-115	NI054	B6406N4	HY-146	GM062	B6719G6	HY-168
VW01340	B1340W4	SHY-115	NI032	B5406N4	JG-146	GM01719	B1719G6	SHY-168
RE022	B6240R4	8HY-119	NI01406	B1406N4	SHY-146	GM024	B6742G4	8HY-169
RE014	B5240R4	8JG-119	RE024	B6380R4	8HY-147	GM024	B6742G4	HY-169
RE022	B6240R4	HY-119	RE016	B5380R4	8JG-147	GM01742	B1742G4	SHY-169
RE014	B5240R4	JG-119	RE024	B6380R4	HY-147	GM089	B6911G4	8HY-170
RE01240	B1240R4	SHY-119	RE016	B5380R4	JG-147	GM089	B6911G4	HY-170
NI034	B6220N4	HY-120	RE01380	B1380R4	SHY-147	GM01911	B1911G4	SEL-170
NI01220	B1220N4	SHY-120	RE021	B6768R4	8HY-148	GM01911	B1911G4	SHY-170
CH065	B6752C8	8HY-126	RE020	B5768R4	8JG-148	NI028	B6402N4	8HY-171
CH021	B5752C8	8JG-126	RE021	B6768R4	HY-148	NI018	B5402N4	8JG-171
CH065	B6752C8	HY-126	RE020	B5768R4	JG-148	NI028	B6402N4	HY-171
CH021	B5752C8	JG-126	RE01768	B1768R4	SHY-148	NI01402	B1402N4	SHY-171
CH01752	B1752C8	SHY-126	RE025	B6524R4	8HY-149	VW056	B6355W4	8HY-172
UN025	B5330U8	8JG-130	RE017	B5524R4	8JG-149	VW035	B5355W4	8JG-172
UN025	B5330U8	C-130	RE025	B6524R4	HY-149	VW056	B6355W4	HY-172
UN025	B5330U8	JG-130	RE017	B5524R4	JG-149	VW035	B5355W4	JG-172
GM022	B6730G8	8HY-132	RE01524	B1524R4	SHY-149	FO059	B6737F4	8HY-173
GM031	B5730G8	8JG-132	ES009	B6813FG8	8HY-150	FO046	B5737F4	EL-173
GM021	B6720G8	8HY-132ELE	ES008	B5813FG8	EL-150	FO01737	B1737F4	SEL-173
GM030	B5720G8	EL-132ELE	FG01813	B1813FG8	SEL-150	FO073	B6739F8	8HY-174
GM022	B6730G8	HY-132	GM023	B6741G6	8HY-151	FO048	B5739F8	EL-174

\* esta es una publicación de información, no constituye un contrato, sin embargo, no asumimos ninguna responsabilidad por errores, cambios, omisiones o daños que resulten de esta.



FO01739	B1739F8	SEL-174
FO0132	B6948F4	8HY-175
FO0131	B5948F4	EL-175
FO01948	B1948F4	SEL-175
FO0127	B6826F4	8HY-176
FO01826	B1826F4	SEL-176
FO0101	B6836F6	8HY-177
FO0100	B5836F6	EL-177
FO01836	B1836F6	SEL-177
FO0162	B69106F6	8HY-178
FO019106	B19106F6	SEL-178
CH029	B6334C4	8HY-179
CH029	B6334C4	HY-179
CH01334	B1334C4	SHY-179
CH037	B6736C6	8HY-180
CH037	B6736C6	HY-180
CH01736	B1736C6	SHY-180
CH038	B6743C6	8HY-181
CH038	B6743C6	HY-181
CH01743	B1743C6	SHY-181
CH027	B6333C4	8HY-183
CH027	B6333C4	HY-183
CH01333	B1333C4	SHY-183
GM0170	B6997G8	8HY-184
GM0170	B6997G8	HY-184
GM01997	B1997G8	SHY-184
NI025	B6531N4	8HY-185
NI025	B6531N4	HY-185
NI01531	B1531N4	SHY-185
NI036	B6530N4	8HY-186
NI036	B6530N4	HY-186
NI01530	B1530N4	SHY-186
FO087	B6815F8	8HY-187
FO01815	B1815F8	SEL-187
GM064	B6726G6	8HY-188
GM063	B5726G6	EL-188
GM01726	B1726G6	SEL-188
GM084	B6829G6	8HY-189
GM078	B5829G6	EL-189
GM084	B6829G6	HY-189
GM01829	B1829G6	SEL-189
GM01829	B1829G6	SHY-189
VW055	B6353W4	8HY-192
VW033	B5353W4	8JG-192
VW033	B5353W4	C-192
VW055	B6353W4	HY-192
VW033	B5353W4	JG-192
VW050	B6962W4	8HY-193
VW050	B6962W4	HY-193
VW037	B6354W4	8HY-194
VW037	B6354W4	HY-194
VW042	B6945W6	8HY-195
VW042	B6945W6	HY-195
VW069	B6947W4	8HY-196
VW091	B5947W4	8JG-196
VW091	B5947W4	C-196
VW069	B6947W4	HY-196
VW091	B5947W4	JG-196
VW056	B6355W4	8HY-197
VW035	B5355W4	8JG-197
VW056	B6355W4	HY-197
VW035	B5355W4	JG-197
VW064	B6936W4	8HY-198
VW064	B6936W4	HY-198
ST002	B6938ST4	8HY-200
ST002	B6938ST4	HY-200
GM0123	B6713G4	8HY-201
GM045	B5713G4	8JG-201
GM0123	B6713G4	HY-201
GM045	B5713G4	JG-201
GM01713	B1713G4	SHY-201
NI062	B6224N4	8HY-202
NI016	B5224N4	8JG-202
NI062	B6224N4	HY-202
NI016	B5224N4	JG-202
NI01224	B1224N4	SHY-202
MZ011	B6817MZ4	8HY-203
MZ008	B5817MZ4	8JG-203
MZ011	B6817MZ4	HY-203
MZ008	B5817MZ4	JG-203
MZ01817	B1817MZ4	SHY-203
FO0123	B6714F4	8HY-204

FO034	B5714F4	8JG-204
FO0123	B6714F4	HY-204
FO034	B5714F4	JG-204
FO01714	B1714F4	SHY-204
FO0126	B6761F4	8HY-205
FO049	B5761F4	8JG-205
FO0126	B6761F4	HY-205
FO049	B5761F4	JG-205
FO01761	B1761F4	SHY-205
TY013	B6721Y4	8HY-206
TY001	B5721Y4	8JG-206
TY001	B5721Y4	C-206
TY013	B6721Y4	HY-206
TY001	B5721Y4	JG-206
TY01721	B1721Y4	SHY-206
GM061	B6203G4	8HY-207
ES007	B5203G4	EL-207
GM01203	B1203G4	SEL-207
FO0130	B6833F4	8HY-208
FO090	B5833F4	EL-208
FO01833	B1833F4	SEL-208
FO0138	B6951F6	8HY-209
FO0137	B5951F6	EL-209
FO01951	B1951F6	SEL-209
FO050	B6202F4	8HY-210
ES001	B5202F4	EL-210
FO01202	B1202F4	SEL-210
FO036	B6201F6	8HY-212
FO021	B5201F6	EL-212
FO01201	B1201F6	SEL-212
NI022	B6221N8	8HY-213
NI021	B5221N8	8JG-213
NI022	B6221N8	HY-213
NI021	B5221N8	JG-213
NI01221	B1221N8	SHY-213
GM0154	B6968G6	8HY-215
GM0153	B5968G6	EL-215
GM01968	B1968G6	SEL-215
FO014	B6700F6	8HY-216
FO019	B5700F6	EL-216
FO01700	B1700F6	SEL-216
FO0111	B6855F8	8HY-217
FO0110	B5855F8	EL-217
FO01855	B1855F8	SEL-217
GM0100	B6715G6	8HY-219
GM044	B5715G6	EL-219
GM01715	B1715G6	SEL-219
NI031	B6231N8	8HY-220
NI019	B5231N8	EL-220
NI01231	B1231N8	SEL-220
MZ009	B5818MZ4	8JG-222
MZ012	B6818MZ4	HY-222
MZ009	B5818MZ4	JG-222
MZ01818	B1818MZ4	SHY-222
TY015	B6723Y4	8HY-223
TY004	B5723Y4	8JG-223
TY015	B6723Y4	HY-223
TY004	B5723Y4	JG-223
TY01723	B1723Y4	SHY-223
TY017	B6812Y6	8HY-224
TY007	B5812Y6	8JG-224
TY007	B5812Y6	C-224
TY017	B6812Y6	HY-224
TY007	B5812Y6	JG-224
TY01812	B1812Y6	SHY-224
CH092	B69124C4	8HY-225
CH092	B69124C4	HY-225
CH019124	B19124C4	SHY-225
GM0144	B6956G8	8HY-226
GM0143	B5956G8	EL-226
GM01956	B1956G8	SEL-226
GM0120	B6927G4	8HY-228
GM0120	B6927G4	HY-228
GM01927	B1927G4	SHY-228
FO0107	B6852F4	8HY-231
FO0106	B5852F4	EL-231
FO01852	B1852F4	SEL-231
GM0174	B6999G8	8HY-232
GM0173	B5999G8	EL-232
GM01999	B1999G8	SEL-232
FO0156	B6991F4	8HY-233
FO0156	B6991F4	HY-233

FO01991	B1991F4	SHY-233
FO0154	B6990F4	8HY-234
FO0154	B6990F4	HY-234
FO01990	B1990F4	SHY-234
FO092	B6912F4	8HY-235
FO01912	B1912F4	SEL-235
FO092	B6912F4	HY-235
FO01912	B1912F4	SHY-235
GM087	B6835G8	8HY-236
GM083	B5835G8	EL-236
GM01835	B1835G8	SEL-236
NI035	B6233N4	8HY-238
NI035	B6233N4	HY-238
NI01233	B1233N4	SEL-238
NI01233	B1233N4	SHY-238
HY006	B6779HY4	HY-239
HY01779	B1779HY4	SHY-239
FO0115	B6937F4	HY-240
FO01937	B1937F4	SHY-240
NI059	B6788N4	HY-244
NI01788	B1788N4	SHY-244
VW073	B69154W5	8HY-246
VW073	B69154W5	HY-246
GM0120	B6927G4	8HY-247
GM0120	B6927G4	HY-247
GM01927	B1927G4	SHY-247
CH062	B6841C6	8HY-251
CH061	B5841C6	8JG-251
CH062	B6841C6	HY-251
CH061	B5841C6	JG-251
CH01841	B1841C6	SHY-251
CH056	B6842C6	8HY-252
CH055	B5842C6	8JG-252
CH056	B6842C6	HY-252
CH055	B5842C6	JG-252
CH01842	B1842C6	SHY-252
GM0160	B6989G8	8HY-257
GM0159	B5989G8	EL-257
GM01989	B1989G8	SEL-257
CH019	B6791C6	8HY-259
CH019	B6791C6	HY-259
CH01791	B1791C6	SHY-259
CH079	B6983C8	8HY-261
CH079	B6983C8	HY-261
CH01983	B1983C8	SHY-261
FO0152	B6978F8	8HY-263
FO0151	B5978F8	EL-263
FO01978	B1978F8	SEL-263
VW067	B69113W4	8HY-264
VW067	B69113W4	HY-264
HY009	B6778HY4	8HY-265
HY009	B6778HY4	HY-265
HY01778	B1778HY4	SHY-265
GM0184	B69136G4	8HY-267
GM0184	B69136G4	HY-267
FO019136	B19136G4	SEL-267
FO019136	B19136G4	SHY-267
FO0162	B69106F6	8HY-269
FO019106	B19106F6	SEL-269
DW017	B69104D4	8HY-271
DW017	B69104D4	HY-271
DW019104	B19104D4	SHY-271
GM0226	B69221G6	8HY-272
GM0226	B69221G6	HY-272
GM019221	B19221G6	SEL-272
GM019221	B19221G6	SHY-272
FO0160	B69105F4	8HY-273
FO0160	B69105F4	HY-273
FO019105	B19105F4	SHY-273
FT010	B69357FT4	HY-274
FT019357	B19357FT4	SHY-274
HY012	B69102HY4	8HY-275
HY012	B69102HY4	HY-275
HY019102	B19102HY4	SEL-275
HY019102	B19102HY4	SHY-275
HY012	B69102HY4	8HY-276
HY012	B69102HY4	HY-276
HY019102	B19102HY4	SEL-276
HY019102	B19102HY4	SHY-276
FT010	B69357FT4	8HY-280
FT010	B69357FT4	HY-280
FT019357	B19357FT4	SEL-280

\*Importante: La información indicada en esta publicación, ha sido obtenida por fuentes confiables y oficiales, consideramos que es correcta, sin embargo no asumimos ninguna responsabilidad por errores, cambios, omisiones o datos que resultaran de estos.

<b>FT019357</b>	<b>B19357FT4</b>	<b>SHY-280</b>
<b>VW071</b>	<b>B69149W4</b>	<b>8HY-283</b>
<b>VW070</b>	<b>B59149W4</b>	<b>C-283</b>
<b>VW071</b>	<b>B69149W4</b>	<b>HY-283</b>
<b>FT011</b>	<b>B69370FT4</b>	<b>HY-284</b>
<b>FT019370</b>	<b>B19370FT4</b>	<b>SHY-284</b>
<b>CH0107</b>	<b>B69304C4</b>	<b>HY-286</b>
<b>CH019304</b>	<b>B19304C4</b>	<b>SHY-286</b>
<b>RE030</b>	<b>B69220R4</b>	<b>8HY-287</b>
<b>RE030</b>	<b>B69220R4</b>	<b>HY-287</b>
<b>RE019220</b>	<b>B19220R4</b>	<b>SEL-287</b>
<b>RE019220</b>	<b>B19220R4</b>	<b>SHY-287</b>
<b>VW093</b>	<b>B69371W4</b>	<b>8HY-294</b>
<b>VW093</b>	<b>B69371W4</b>	<b>HY-294</b>
<b>VW019371</b>	<b>B19371W4</b>	<b>SEL-294</b>
<b>VW019371</b>	<b>B19371W4</b>	<b>SHY-294</b>
<b>GM0280</b>	<b>B69359G3</b>	<b>8HY-2306</b>
<b>GM0279</b>	<b>B59359G3</b>	<b>EL-2306</b>
<b>GM019359</b>	<b>B19359G3</b>	<b>SEL-2306</b>
<b>GM0280</b>	<b>B69359G3</b>	<b>HY-2307</b>
<b>GM019359</b>	<b>B19359G3</b>	<b>SHY-2307</b>
<b>CH051</b>	<b>B5907C4</b>	<b>8JG-2416</b>
<b>CH053</b>	<b>B6907C4</b>	<b>HY-2416</b>
<b>CH01907</b>	<b>B1907C4</b>	<b>SEL-2416</b>
<b>CH01907</b>	<b>B1907C4</b>	<b>SHY-2416</b>
<b>CH087</b>	<b>B6988C4</b>	<b>8HY-2419</b>
<b>CH086</b>	<b>B5988C4</b>	<b>8JG-2419</b>
<b>CH087</b>	<b>B6988C4</b>	<b>HY-2419</b>
<b>CH086</b>	<b>B5988C4</b>	<b>JG-2419</b>
<b>CH01988</b>	<b>B1988C4</b>	<b>SHY-2419</b>
<b>CH060</b>	<b>B6857C4</b>	<b>8HY-2420</b>
<b>CH060</b>	<b>B6857C4</b>	<b>HY-2420</b>
<b>CH01857</b>	<b>B1857C4</b>	<b>SHY-2420</b>
<b>CH019107</b>	<b>B19107C4</b>	<b>SEL-2423</b>
<b>CH019107</b>	<b>B19107C4</b>	<b>SHY-2423</b>
<b>CH060</b>	<b>B6857C4</b>	<b>8HY-2483</b>
<b>CH059</b>	<b>B5857C4</b>	<b>EL-2483</b>
<b>CH01857</b>	<b>B1857C4</b>	<b>SEL-2483</b>
<b>GM0208</b>	<b>B69175G4</b>	<b>8HY-2484</b>
<b>GM0207</b>	<b>B59175G4</b>	<b>EL-2484</b>
<b>GM0208</b>	<b>B69175G4</b>	<b>HY-2484</b>
<b>GM019175</b>	<b>B19175G4</b>	<b>SEL-2484</b>
<b>GM019175</b>	<b>B19175G4</b>	<b>SHY-2484</b>
<b>CH054</b>	<b>B6908C6</b>	<b>8HY-2608</b>
<b>CH052</b>	<b>B5908C6</b>	<b>EL-2608</b>
<b>CH01908</b>	<b>B1908C6</b>	<b>SEL-2608</b>
<b>CH069</b>	<b>B6820C6</b>	<b>8HY-2615</b>
<b>CH048</b>	<b>B5820C6</b>	<b>8JG-2615</b>
<b>CH069</b>	<b>B6820C6</b>	<b>HY-2615</b>
<b>CH01820</b>	<b>B1820C6</b>	<b>SHY-2615</b>
<b>CH054</b>	<b>B6908C6</b>	<b>8HY-2616</b>
<b>CH052</b>	<b>B5908C6</b>	<b>EL-2616</b>
<b>CH01908</b>	<b>B1908C6</b>	<b>SEL-2616</b>
<b>CH067</b>	<b>B6970C6</b>	<b>8HY-2623</b>
<b>CH067</b>	<b>B6970C6</b>	<b>HY-2623</b>
<b>CH01970</b>	<b>B1970C6</b>	<b>SHY-2623</b>
<b>CH044</b>	<b>B6782C8</b>	<b>8HY-2873</b>
<b>CH043</b>	<b>B5782C8</b>	<b>EL-2873</b>
<b>CH01782</b>	<b>B1782C8</b>	<b>SEL-2873</b>
<b>GM0256</b>	<b>B69263G8</b>	<b>8HY-2878</b>
<b>GM0255</b>	<b>B59263G8</b>	<b>EL-2878</b>
<b>GM019263</b>	<b>B19263G8</b>	<b>SEL-2878</b>
<b>GM0192</b>	<b>B69152G4</b>	<b>8HY-2903</b>
<b>GM0191</b>	<b>B59152G4</b>	<b>EL-2903</b>
<b>GM019152</b>	<b>B19152G4</b>	<b>SEL-2903</b>
<b>GM0232</b>	<b>B69230G8</b>	<b>8HY-2905</b>
<b>GM0231</b>	<b>B59230G8</b>	<b>EL-2905</b>
<b>GM019230</b>	<b>B19230G8</b>	<b>SEL-2905</b>
<b>GM0214</b>	<b>B69189G8</b>	<b>8HY-2907</b>
<b>GM0213</b>	<b>B59189G8</b>	<b>EL-2907</b>
<b>GM019189</b>	<b>B19189G8</b>	<b>SEL-2907</b>
<b>SN002</b>	<b>B69150SN4</b>	<b>8HY-2909</b>
<b>SN001</b>	<b>B59150SN4</b>	<b>EL-2909</b>
<b>SN019150</b>	<b>B19150SN4</b>	<b>SEL-2909</b>
<b>GM0144</b>	<b>B6956G8</b>	<b>8HY-2910</b>
<b>GM0143</b>	<b>B5956G8</b>	<b>EL-2910</b>
<b>GM01956</b>	<b>B1956G8</b>	<b>SEL-2910</b>
<b>GM0192</b>	<b>B69152G4</b>	<b>8HY-2913</b>
<b>GM0191</b>	<b>B59152G4</b>	<b>EL-2913</b>
<b>GM0192</b>	<b>B69152G4</b>	<b>HY-2913</b>

<b>GM019152</b>	<b>B19152G4</b>	<b>SEL-2913</b>
<b>GM019152</b>	<b>B19152G4</b>	<b>SHY-2913</b>
<b>GM0244</b>	<b>B69257G6</b>	<b>8HY-2914</b>
<b>GM0243</b>	<b>B59257G6</b>	<b>EL-2914</b>
<b>GM019257</b>	<b>B19257G6</b>	<b>SEL-2914</b>
<b>GM0200</b>	<b>B69164G6</b>	<b>8HY-2915</b>
<b>GM0199</b>	<b>B59164G6</b>	<b>EL-2915</b>
<b>GM019164</b>	<b>B19164G6</b>	<b>SEL-2915</b>
<b>GM0166</b>	<b>B6995G8</b>	<b>8HY-2916</b>
<b>GM0165</b>	<b>B5995G8</b>	<b>EL-2916</b>
<b>GM01995</b>	<b>B1995G8</b>	<b>SEL-2916</b>
<b>GM0170</b>	<b>B6997G8</b>	<b>8HY-2918</b>
<b>GM0171</b>	<b>B5998G4</b>	<b>EL-2918</b>
<b>GM01998</b>	<b>B1998G4</b>	<b>SEL-2918</b>
<b>GM0252</b>	<b>B69261G8</b>	<b>8HY-2920</b>
<b>GM0251</b>	<b>B59261G8</b>	<b>EL-2920</b>
<b>GM019261</b>	<b>B19261G8</b>	<b>SEL-2920</b>
<b>GM0110</b>	<b>B6856G6</b>	<b>8HY-2922</b>
<b>GM0109</b>	<b>B5856G6</b>	<b>EL-2922</b>
<b>GM01856</b>	<b>B1856G6</b>	<b>SEL-2922</b>
<b>GM0106</b>	<b>B6850G6</b>	<b>8HY-2924</b>
<b>GM0105</b>	<b>B5850G6</b>	<b>EL-2924</b>
<b>GM0106</b>	<b>B6850G6</b>	<b>HY-2924</b>
<b>GM01850</b>	<b>B1850G6</b>	<b>SEL-2924</b>
<b>GM01850</b>	<b>B1850G6</b>	<b>SHY-2924</b>
<b>GM0198</b>	<b>B69163G6</b>	<b>8HY-2930</b>
<b>GM0197</b>	<b>B59163G6</b>	<b>EL-2930</b>
<b>GM019163</b>	<b>B19163G6</b>	<b>SEL-2930</b>
<b>GM0246</b>	<b>B69258G8</b>	<b>8HY-2940</b>
<b>GM0245</b>	<b>B59258G8</b>	<b>EL-2940</b>
<b>GM019258</b>	<b>B19258G8</b>	<b>SEL-2940</b>
<b>GM0238</b>	<b>B69254G4</b>	<b>8HY-2941</b>
<b>GM0237</b>	<b>B59254G4</b>	<b>EL-2941</b>
<b>GM019254</b>	<b>B19254G4</b>	<b>SEL-2941</b>
<b>GM0240</b>	<b>B69255G6</b>	<b>8HY-2945</b>
<b>GM0239</b>	<b>B59255G6</b>	<b>EL-2945</b>
<b>GM019255</b>	<b>B19255G6</b>	<b>SEL-2945</b>
<b>GM0102</b>	<b>B6837G8</b>	<b>8HY-2946</b>
<b>GM0101</b>	<b>B5837G8</b>	<b>EL-2946</b>
<b>GM01837</b>	<b>B1837G8</b>	<b>SEL-2946</b>
<b>GM081</b>	<b>B6336G4</b>	<b>HY-2950</b>
<b>GM01336</b>	<b>B1336G4</b>	<b>SHY-2950</b>
<b>GM0130</b>	<b>B6282G4</b>	<b>8HY-2951</b>
<b>GM072</b>	<b>B5282G4</b>	<b>EL-2951</b>
<b>GM01282</b>	<b>B1282G4</b>	<b>SEL-2951</b>
<b>GM0234</b>	<b>B69231G8</b>	<b>8HY-2957</b>
<b>GM0233</b>	<b>B59231G8</b>	<b>EL-2957</b>
<b>GM019231</b>	<b>B19231G8</b>	<b>SEL-2957</b>
<b>GM0254</b>	<b>B69262G8</b>	<b>8HY-2958</b>
<b>GM0253</b>	<b>B59262G8</b>	<b>EL-2958</b>
<b>GM019262</b>	<b>B19262G8</b>	<b>SEL-2958</b>
<b>GM0108</b>	<b>B6851G6</b>	<b>8HY-2959</b>
<b>GM0107</b>	<b>B5851G6</b>	<b>EL-2959</b>
<b>GM01851</b>	<b>B1851G6</b>	<b>SEL-2959</b>
<b>FO0128</b>	<b>B6827F6</b>	<b>8HY-2961</b>
<b>FO088</b>	<b>B5827F6</b>	<b>EL-2961</b>
<b>FO01827</b>	<b>B1827F6</b>	<b>SEL-2961</b>
<b>FO098</b>	<b>B6717F8</b>	<b>8HY-2965</b>
<b>FO035</b>	<b>B5717F8</b>	<b>EL-2965</b>
<b>FO01717</b>	<b>B1717F8</b>	<b>SEL-2965</b>
<b>FO0101</b>	<b>B6836F6</b>	<b>8HY-2968</b>
<b>FO0100</b>	<b>B5836F6</b>	<b>EL-2968</b>
<b>FO01836</b>	<b>B1836F6</b>	<b>SEL-2968</b>
<b>FO087</b>	<b>B6815F8</b>	<b>8HY-2969</b>
<b>FO086</b>	<b>B5815F8</b>	<b>EL-2969</b>
<b>FO01815</b>	<b>B1815F8</b>	<b>SEL-2969</b>
<b>FO0103</b>	<b>B6840F4</b>	<b>8HY-2970</b>
<b>FO0102</b>	<b>B5840F4</b>	<b>EL-2970</b>
<b>FO01840</b>	<b>B1840F4</b>	<b>SEL-2970</b>
<b>FO077</b>	<b>B6769F8</b>	<b>8HY-2972</b>
<b>FO058</b>	<b>B5769F8</b>	<b>EL-2972</b>
<b>FO01769</b>	<b>B1769F8</b>	<b>SEL-2972</b>
<b>FO0195</b>	<b>B69172F4</b>	<b>8HY-2984</b>
<b>FO0195</b>	<b>B69172F4</b>	<b>HY-2984</b>
<b>FO019172</b>	<b>B19172F4</b>	<b>SHY-2984</b>
<b>FO0119</b>	<b>B6784F8</b>	<b>8HY-2989</b>
<b>FO027</b>	<b>B5784F8</b>	<b>EL-2989</b>
<b>FO01784</b>	<b>B1784F8</b>	<b>SEL-2989</b>
<b>FO0213</b>	<b>B69378F4</b>	<b>8HY-2991</b>
<b>FO0212</b>	<b>B59378F4</b>	<b>EL-2991</b>

<b>FO019378</b>	<b>B19378F4</b>	<b>SEL-2991</b>
<b>FO076</b>	<b>B6716F8</b>	<b>8HY-2993</b>
<b>FO042</b>	<b>B5716F8</b>	<b>EL-2993</b>
<b>FO01716</b>	<b>B1716F8</b>	<b>SEL-2993</b>
<b>GM0154</b>	<b>B6968G6</b>	<b>8HY-3102</b>
<b>GM01968</b>	<b>B1968G6</b>	<b>SEL-3102</b>
<b>GM0242</b>	<b>B69256G6</b>	<b>8HY-3107</b>
<b>GM0241</b>	<b>B59256G6</b>	<b>EL-3107</b>
<b>GM019256</b>	<b>B19256G6</b>	<b>SEL-3107</b>
<b>GM0260</b>	<b>B69270G6</b>	<b>8HY-3109</b>
<b>GM019270</b>	<b>B19270G6</b>	<b>SEL-3109</b>
<b>GM0108</b>	<b>B6851G6</b>	<b>8HY-3110</b>
<b>GM01851</b>	<b>B1851G6</b>	<b>SEL-3110</b>
<b>GM0132</b>	<b>B6828G4</b>	<b>8HY-3111</b>
<b>GM01828</b>	<b>B1828G4</b>	<b>SEL-3111</b>
<b>GM0104</b>	<b>B6846G6</b>	<b>8HY-3112</b>
<b>GM0103</b>	<b>B5846G6</b>	<b>EL-3112</b>
<b>GM01846</b>	<b>B1846G6</b>	<b>SEL-3112</b>
<b>GM0202</b>	<b>B69165G4</b>	<b>8HY-3113</b>
<b>GM019165</b>	<b>B19165G4</b>	<b>SEL-3113</b>
<b>GM039</b>	<b>B6731G8</b>	<b>8HY-3114</b>
<b>GM038</b>	<b>B5731G8</b>	<b>EL-3114</b>
<b>GM01731</b>	<b>B1731G8</b>	<b>SEL-3114</b>
<b>GM0287</b>	<b>B69385G6</b>	<b>8HY-3115</b>
<b>GM0296</b>	<b>B59385G6</b>	<b>EL-3115</b>
<b>GM019385</b>	<b>B19385G6</b>	<b>SEL-3115</b>
<b>GM0250</b>	<b>B69260G8</b>	<b>8HY-3116</b>
<b>GM0250</b>	<b>B69260G8</b>	<b>HY-3116</b>
<b>GM019260</b>	<b>B19260G8</b>	<b>SEL-3116</b>
<b>GM019260</b>	<b>B19260G8</b>	<b>SHY-3116</b>
<b>GM0164</b>	<b>B6994G6</b>	<b>8HY-3118</b>
<b>GM0164</b>	<b>B6994G6</b>	<b>HY-3118</b>
<b>GM01994</b>	<b>B1994G6</b>	<b>SEL-3118</b>
<b>GM01994</b>	<b>B1994G6</b>	<b>SHY-3118</b>
<b>GM0148</b>	<b>B6961G8</b>	<b>8HY-3119</b>
<b>GM0147</b>	<b>B5961G8</b>	<b>EL-3119</b>
<b>GM01961</b>	<b>B1961G8</b>	<b>SEL-3119</b>
<b>GM0230</b>	<b>B69229G8</b>	<b>8HY-3120</b>
<b>GM0229</b>	<b>B59229G8</b>	<b>EL-3120</b>
<b>GM019229</b>	<b>B19229G8</b>	<b>SEL-3120</b>
<b>GM0236</b>	<b>B69228G8</b>	<b>8HY-3121</b>
<b>GM0235</b>	<b>B59228G8</b>	<b>EL-3121</b>
<b>GM019228</b>	<b>B19228G8</b>	<b>SEL-3121</b>
<b>GM0168</b>	<b>B6996G8</b>	<b>8HY-3123</b>
<b>GM01996</b>	<b>B1996G8</b>	<b>SEL-3123</b>
<b>GM0170</b>	<b>B6997G8</b>	<b>8HY-3124</b>
<b>GM01997</b>	<b>B1997G8</b>	<b>SEL-3124</b>
<b>GM0134</b>	<b>B6941G6</b>	<b>8HY-3125</b>
<b>GM01941</b>	<b>B1941G6</b>	<b>SEL-3125</b>
<b>GM0264</b>	<b>B69274G8</b>	<b>8HY-3126</b>
<b>GM019274</b>	<b>B19274G8</b>	<b>SEL-3126</b>
<b>GM0204</b>	<b>B69166G4</b>	<b>8HY-3128</b>
<b>GM019166</b>	<b>B19166G4</b>	<b>SEL-3128</b>
<b>GM0146</b>	<b>B6957G8</b>	<b>8HY-3130</b>
<b>GM01957</b>	<b>B1957G8</b>	<b>SEL-3130</b>
<b>GM0164</b>	<b>B6994G6</b>	<b>8HY-3133</b>
<b>GM01994</b>	<b>B1994G6</b>	<b>SEL-3133</b>
<b>GM0162</b>	<b>B6993G6</b>	<b>8HY-3134</b>
<b>GM01993</b>	<b>B1993G6</b>	<b>SEL-3134</b>
<b>GM0272</b>	<b>B69303G6</b>	<b>8HY-3136</b>
<b>GM019303</b>	<b>B19303G6</b>	<b>SEL-3136</b>
<b>GM098</b>	<b>B6917G8</b>	<b>8HY-3137</b>
<b>GM01917</b>	<b>B1917G8</b>	<b>SEL-3137</b>
<b>GM0117</b>	<b>B6928G8</b>	<b>8HY-3138</b>
<b>GM01928</b>	<b>B1928G8</b>	<b>SEL-3138</b>
<b>GM0132</b>	<b>B6828G4</b>	<b>8HY-3139</b>
<b>GM01828</b>	<b>B1828G4</b>	<b>SEL-3139</b>
<b>GM0186</b>	<b>B69137G6</b>	<b>HY-3142</b>
<b>GM019137</b>	<b>B19137G6</b>	<b>SHY-3142</b>
<b>GM0119</b>	<b>B6929G4</b>	<b>8HY-3143</b>
<b>GM0119</b>	<b>B6929G4</b>	<b>HY-3143</b>
<b>GM01929</b>	<b>B1929G4</b>	<b>SEL-3143</b>
<b>GM01929</b>	<b>B1929G4</b>	<b>SHY-3143</b>
<b>GM0162</b>	<b>B6993G6</b>	<b>8HY-3144</b>
<b>GM0162</b>	<b>B6993G6</b>	<b>HY-3144</b>
<b>GM01993</b>	<b>B1993G6</b>	<b>SEL-3144</b>
<b>GM01993</b>	<b>B1993G6</b>	<b>SHY-3144</b>
<b>GM0194</b>	<b>B69159G4</b>	<b>8HY-3145</b>
<b>GM019159</b>	<b>B19159G4</b>	<b>SEL-3145</b>
<b>GM0156</b>	<b>B6971G6</b>	<b>8HY-3146</b>



\*Importante: La información indicada en esta publicación, ha sido obtenida por fuentes confiables y oficiales, consideramos que es correcta, sin embargo no asumimos ninguna responsabilidad por errores, cambios, omisiones o datos que resultaron de estos.\*

Cahsa			Hy Power			GARLO			Cahsa			Hy Power			GARLO		
GM0156	B6971G6	HY-3146	FO019138	B19138F6	SEL-3308	MC019142	B19142MC4	SHY-4323									
GM01971	B1971G6	SEL-3146	FO0170	B69129F6	HY-3310	TY026	B69158Y4	8HY-4340									
GM01971	B1971G6	SHY-3146	FO019129	B19129F6	SHY-3310	TY026	B69158Y4	HY-4340									
GM0140	B6954G8	8HY-3147	FO074	B6744F8	8HY-3311	TY025	B59158Y4	JG-4340									
GM0140	B6954G8	HY-3147	FO022	B5744F8	EL-3311	TY019158	B19158Y4	SHY-4340									
GM01954	B1954G8	SEL-3147	FO01744	B1744F8	SEL-3311	VW013	B6360W4	8HY-4354									
GM01954	B1954G8	SHY-3147	FO0187	B69168F6	8HY-3317	VW016	B5360W4	8JG-4354									
GM0131	B6283G6	8HY-3150	FO019168	B19168F6	SEL-3317	VW016	B5360W4	C-4354									
GM01283	B1283G6	SEL-3150	FO0142	B6973F6	8HY-3318	VW016	B5360W4	EL-4354									
GM0262	B69273G6	8HY-3151	FO01973	B1973F6	SEL-3318	VW013	B6360W4	HY-4354									
GM0262	B69273G6	HY-3151	FO065	B6734F6	8HY-3319	VW01360	B1360W4	SEL-4354									
GM019273	B19273G6	SEL-3151	FO044	B5734F6	EL-3319	VW051	B5969W4	8JG-4392									
GM019273	B19273G6	SHY-3151	FO01734	B1734F6	SEL-3319	VW051	B5969W4	C-4392									
GM0140	B6954G8	8HY-3152	FO079	B6751F6	8HY-3320	VW051	B5969W4	EL-4392									
GM01954	B1954G8	SEL-3152	FO01951	B1951F6	SEL-3320	VW068	B6969W4	HY-4392									
GM0134	B6941G6	8HY-3154	FO072	B6728F8	HY-3321	VW049	B5962W4	C-4395									
GM01941	B1941G6	SEL-3154	FO01728	B1728F8	SHY-3321	VW050	B6962W4	HY-4395									
GM01952	B1952G6	SEL-3155	FO069	B6724F8	8HY-3322	DH002	B6803DH4	8HY-4403									
GM01952	B1952G6	SHY-3155	FO054	B5724F8	EL-3322	DH002	B6803DH4	HY-4403									
GM085	B6830G4	8HY-3156	FO01724	B1724F8	SEL-3322	DH01803	B1803DH4	SHY-4403									
GM079	B5830G4	EL-3156	FO0146	B6975F6	8HY-3325	DH004	B69324DH4	HY-4404									
GM01830	B1830G4	SEL-3156	FO0145	B5975F6	EL-3325	DH019324	B19324DH4	SHY-4404									
GM0300	B69389G4	8HY-3157	FO01975	B1975F6	SEL-3325	DW007	B6204D4	8HY-4406									
GM0290	B59389G4	EL-3157	FO0176	B69132F6	8HY-3326	DW007	B6204D4	HY-4406									
GM019389	B19389G4	SEL-3157	FO019132	B19132F6	SEL-3326	DW01204	B1204D4	SHY-4406									
GM0224	B69219G8	8HY-3160	FO0193	B69171F8	8HY-3327	GM0206	B69167G4	8HY-4407									
GM019219	B19219G8	SEL-3160	FO019171	B19171F8	SEL-3327	GM0206	B69167G4	HY-4407									
GM019219	B19219G8	SHY-3160	FO070	B6725F8	8HY-3328	GM019167	B19167G4	SEL-4407									
GM0224	B69219G8	8HY-3162	FO055	B5725F8	EL-3328	GM019167	B19167G4	SHY-4407									
GM019219	B19219G8	SEL-3162	FO01725	B1725F8	SEL-3328	GM0196	B69161G4	8HY-4408									
CH0109	B69393C4	8HY-3165	FO070	B6725F8	8HY-3329	GM0196	B69161G4	HY-4408									
CH019393	B19393C4	SEL-3165	FO055	B5725F8	EL-3329	GM019161	B19161G4	SHY-4408									
GM0299	B69390G6	8HY-3166	FO01725	B1725F8	SEL-3329	MI022	B69209M4	8HY-4475									
GM0299	B69390G6	HY-3166	FO0150	B6977F6	8HY-3332	MI022	B69209M4	HY-4475									
GM019390	B19390G6	SEL-3166	FO01977	B1977F6	SEL-3332	MI019209	B19209M4	SHY-4475									
GM019390	B19390G6	SHY-3166	FO059	B6737F4	8HY-3333	MI018	B69179MI4	8HY-4476									
CH0101	B69173C10	8HY-3201	FO059	B6737F4	HY-3333	MI018	B69179MI4	HY-4476									
CH0101	B69173C10	HY-3201	FO01737	B1737F4	SEL-3333	MI019179	B19179MI4	SHY-4476									
CH019173	B19173C10	SEL-3201	FO01737	B1737F4	SHY-3333	TY030	B69181Y4	8HY-4502									
CH019173	B19173C10	SHY-3201	FO0144	B6974F6	8HY-3334	TY030	B69181Y4	HY-4502									
CH093	B69123C10	8HY-3202	FO01974	B1974F6	SEL-3334	TY029	B59181Y4	JG-4502									
CH093	B69123C10	HY-3202	FO094	B6913F4	HY-3335	TY019181	B19181Y4	SHY-4502									
CH019123	B19123C10	SEL-3202	FO01913	B1913F4	SHY-3335	TY038	B69247Y4	HY-4516									
CH019123	B19123C10	SHY-3202	FO092	B6912F4	8HY-3336	TY019247	B19247Y4	SHY-4516									
CH071	B6825C6	8HY-3204	FO092	B6912F4	HY-3336	TY036	B69211Y4	8HY-4517									
CH071	B6825C6	HY-3204	FO01912	B1912F4	SEL-3336	TY036	B69211Y4	HY-4517									
CH01825	B1825C6	SHY-3204	FO01912	B1912F4	SHY-3336	TY019211	B19211Y4	SEL-4517									
CH097	B69160C6	8HY-3207	FO0168	B69125F6	8HY-3337	TY019211	B19211Y4	SHY-4517									
CH097	B69160C6	HY-3207	FO019125	B19125F6	SEL-3337	TY012	B6535Y4	HY-4518									
CH019160	B19160C6	SEL-3207	FO0191	B69170F6	8HY-3339	TY01535	B1535Y4	SHY-4518									
CH019160	B19160C6	SHY-3207	FO019170	B19170F6	SEL-3339	GM0210	B69176G4	8HY-4541									
CH019174	B19174C10	SEL-3209	FO0199	B69235F6	8HY-3340	GM0210	B69176G4	HY-4541									
CH019174	B19174C10	SHY-3209	FO019235	B19235F6	SEL-3340	GM019176	B19176G4	SHY-4541									
CH094	B6965C4	HY-3210	FO0189	B69169F6	8HY-3341	GM0208	B69175G4	8HY-4542									
CH01965	B1965C4	SHY-3210	FO019169	B19169F6	SEL-3341	GM0208	B69175G4	HY-4542									
CH081	B6985C6	8HY-3211	FO0144	B6974F6	8HY-3343	GM019175	B19175G4	SHY-4542									
CH081	B6985C6	HY-3211	FO01974	B1974F6	SEL-3343	TY056	B69344Y4	HY-4544									
CH01985	B1985C6	SHY-3211	FO079	B6751F6	8HY-3344	TY019344	B19344Y4	SHY-4544									
GM019394	B19394G6	SEL-3214	FO01751	B1751F6	SEL-3344	TY034	B69210Y4	HY-4551									
GM019394	B19394G6	SHY-3214	FO0164	B69112F6	8HY-3347	TY019210	B19210Y4	SHY-4551									
FO0215	B69392F6	8HY-3215	FO019112	B19112F6	SEL-3347	TY047	B69252Y4	5SHY-4564									
FO019392	B19392F6	SEL-3215	FO0158	B6932F6	8HY-3348	TY060	B69363Y4	5SHY-4565									
FO019392	B19392F6	SHY-3215	FO01992	B1992F6	SEL-3348	TY061	B69364Y4	5SHY-4566									
CH019236	B19236C8	SEL-3216	FO0176	B69132F6	8HY-3349	TY027	B69162Y4	5SHY-4568									
CH019236	B19236C8	SHY-3216	FO019132	B19132F6	SEL-3349	TY023	B69143Y4	5HY-4569									
FO071	B6727F8	8HY-3303	FO0148	B6976F6	8HY-3350	TY011	B6932Y4	5SHY-4572									
FO056	B5727F8	EL-3303	FO0148	B6976F6	HY-3350	TY032	B69208Y4	HY-4574									
FO01727	B1727F8	SEL-3303	FO01976	B1976F6	SEL-3350	TY019208	B19208Y4	SHY-4574									
FO0187	B69168F6	8HY-3304	FO0176	B69132F6	8HY-3351	TY010	B6931Y2	5SHY-4575									
FO019168	B19168F6	SEL-3304	FO019132	B19132F6	SEL-3351	TY039	B69253Y4	5SHY-4576									
MZ016	B6793MZ4	8HY-3305	FO0180	B69135F4	8HY-3352	TY062	B69290Y4	5SHY-4577									
MZ016	B6793MZ4	HY-3305	FO0179	B59135F4	EL-3352	TY059	B69362Y4	5SHY-4578									
MZ01793	B1793MZ4	SEL-3305	FO019135	B19135F4	SEL-3352	FO050	B6202F4	8HY-4580									
MZ01793	B1793MZ4	SHY-3305	FO0197	B69222F6	8HY-3353	FO050	B6202F4	HY-4580									
FO066	B6735F6	8HY-3306	FO019222	B19222F6	SEL-3353	FO01202	B1202F4	SHY-4580									
FO01735	B1735F6	SEL-3306	GM019391	B19391G8	SEL-3356	CH058	B6849C4	8HY-4588									
FO066	B6735F6	8HY-3307	GM019391	B19391G8	SHY-3356	CH058	B6849C4	HY-4588									
FO01735	B1735F6	SEL-3307	MC002	B69142MC4	8HY-4323	CH01849	B1849C4	SHY-4588									
FO0182	B69138F6	8HY-3308	MC002	B69142MC4	HY-4323	MI015	B69128MI4	5HY-4589									
						IS010	B69188I4	8HY-4597									

<b>ISO10</b>	B69188I4	HY-4597
<b>ISO19188</b>	B19188I4	SHY-4597
<b>NIO90</b>	B69289N4	HY-4609
<b>NIO19289</b>	B19289N4	SHY-4609
<b>GM0208</b>	B69175G4	8HY-4612
<b>GM0208</b>	B69175G4	HY-4612
<b>GM0207</b>	B59175G4	JG-4612
<b>GM019175</b>	B19175G4	SHY-4612
<b>NI073</b>	B69153N4	8HY-4652
<b>NI073</b>	B69153N4	HY-4652
<b>NI019153</b>	B19153N4	SHY-4652
<b>NI052</b>	B6982N4	8HY-4658
<b>NI052</b>	B6982N4	HY-4658
<b>NI01982</b>	B1982N4	SHY-4658
<b>MI040</b>	B69372M4	5SHY-4675
<b>HY024</b>	B69283HY4	HY-4676
<b>HY019283</b>	B19283HY4	SHY-4676
<b>HY008</b>	B6774HY4	8HY-4677
<b>HY008</b>	B6774HY4	HY-4677
<b>HY01774</b>	B1774HY4	SHY-4677
<b>HY007</b>	B6771HY4	HY-4678
<b>HY01771</b>	B1771HY4	SHY-4678
<b>CH075</b>	B6824C4	8HY-4680
<b>CH047</b>	B5824C4	8JG-4680
<b>CH075</b>	B6824C4	HY-4680
<b>CH047</b>	B5824C4	JG-4680
<b>CH01824</b>	B1824C4	SHY-4680
<b>CH058</b>	B6849C4	8HY-4681
<b>CH058</b>	B6849C4	HY-4681
<b>CH01849</b>	B1849C4	SHY-4681
<b>HY028</b>	B69300HY4	HY-4683
<b>HY019300</b>	B19300HY4	SHY-4683
<b>HN018</b>	B69265HN4	8HY-4684
<b>HN018</b>	B69265HN4	HY-4684
<b>HN017</b>	B59265HN4	JG-4684
<b>HN019265</b>	B19265HN4	SHY-4684
<b>MI010</b>	B69120M4	HY-4686
<b>MI019120</b>	B19120M4	SHY-4686
<b>MI006</b>	B6781M4	HY-4687
<b>MI01781</b>	B1781M4	SHY-4687
<b>MI020</b>	B69180MI4	HY-4688
<b>MI019180</b>	B19180MI4	SHY-4688
<b>HY022</b>	B69279HY4	8HY-4689
<b>HY022</b>	B69279HY4	HY-4689
<b>HY019279</b>	B19279HY4	SHY-4689
<b>NI035</b>	B6233N4	8HY-4693
<b>NI035</b>	B6233N4	HY-4693
<b>NI01233</b>	B1233N4	SHY-4693
<b>NI067</b>	B69100N4	HY-4696
<b>NI019100</b>	B19100N4	SHY-4696
<b>NI077</b>	B69276N4	HY-4697
<b>NI019276</b>	B19276N4	SHY-4697
<b>MI040</b>	B69372MI4	5HY-4698
<b>HN022</b>	B69323HN4	8HY-4702
<b>HN021</b>	B59323HN4	8JG-4702
<b>HN022</b>	B69323HN4	HY-4702
<b>HN021</b>	B59323HN4	JG-4702
<b>HN019323</b>	B19323HN4	SHY-4702
<b>HN011</b>	B69117HN4	8HY-4703
<b>HN011</b>	B69117HN4	HY-4703
<b>HN019117</b>	B19117HN4	SHY-4703
<b>HN020</b>	B69266HN4	8HY-4704
<b>HN019</b>	B59266HN4	8JG-4704
<b>HN020</b>	B69266HN4	HY-4704
<b>HN019</b>	B59266HN4	JG-4704
<b>HN019266</b>	B19266HN4	SHY-4704
<b>HN022</b>	B69323HN4	8HY-4706
<b>HN022</b>	B69323HN4	HY-4706
<b>HN019323</b>	B19323HN4	SHY-4706
<b>HN014</b>	B69182HN4	8HY-4708
<b>HN014</b>	B69182HN4	HY-4708
<b>HN013</b>	B59182HN4	JG-4708
<b>HN019182</b>	B19182HN4	SHY-4708
<b>HN018</b>	B69265HN4	8HY-4711
<b>HN018</b>	B69265HN4	HY-4711
<b>HN019265</b>	B19265HN4	SEL-4711
<b>HN019265</b>	B19265HN4	SHY-4711
<b>HN005</b>	B6980HN4	HY-4713







<b>HNO1980</b>	B1980HN4	SHY-4713
<b>HNO28</b>	B69326HN4	HY-4714
<b>HNO19326</b>	B19326HN6	SHY-4714
<b>HN008</b>	B6814HN4	HY-4716
<b>HN01814</b>	B1814HN4	SHY-4716
<b>HN003</b>	B6979HN4	HY-4717
<b>HN01979</b>	B1979HN4	SHY-4717
<b>HN003</b>	B6979HN4	HY-4732
<b>HN01979</b>	B1979HN4	SHY-4732
<b>MZO18</b>	B6816MZ4	8HY-4740
<b>MZO07</b>	B5816MZ4	8JG-4704
<b>MZO18</b>	B6816MZ4	HY-4740
<b>MZO07</b>	B5816MZ4	JG-4704
<b>MZO1816</b>	B1816MZ4	SHY-4740
<b>KI003</b>	B6775K4	8HY-4741
<b>KI003</b>	B6775K4	HY-4741
<b>KI01775</b>	B1775K4	SHY-4741
<b>MZO32</b>	B69271MZ4	HY-4744
<b>MZO19271</b>	B19271MZ4	SHY-4744
<b>KI006</b>	B69187K4	8HY-4746
<b>KI006</b>	B69187K4	HY-4746
<b>KI019187</b>	B19187K4	SHY-4746
<b>KI022</b>	B69328K4	HY-4747
<b>KI019328</b>	B19328K4	SHY-4747
<b>KI024</b>	B69302K4	HY-4748
<b>KI019302</b>	B19302K4	SHY-4748
<b>MZO20</b>	B6909MZ4	HY-4768
<b>MZO1909</b>	B1909MZ4	SHY-4768
<b>MZO16</b>	B6793MZ4	8HY-4769
<b>MZO16</b>	B6793MZ4	HY-4769
<b>MZO1793</b>	B1793MZ4	SHY-4769
<b>MZO15</b>	B6759MZ4	8HY-4770
<b>MZO03</b>	B5759MZ4	8JG-4770
<b>MZO15</b>	B6759MZ4	HY-4770
<b>MZO03</b>	B5759MZ4	JG-4770
<b>MZO1759</b>	B1759MZ4	SHY-4770
<b>MZO30</b>	B69267MZ6	8HY-4772
<b>MZO30</b>	B69267MZ6	HY-4772
<b>MZO19267</b>	B19267MZ6	SHY-4772
<b>MZO11</b>	B6817MZ4	8HY-4773
<b>MZO11</b>	B6817MZ4	HY-4773
<b>MZO1817</b>	B1817MZ4	SHY-4773
<b>MZO11</b>	B6817MZ4	8HY-4774
<b>MZO11</b>	B6817MZ4	HY-4774
<b>MZO1817</b>	B1817MZ4	SHY-4774
<b>MZO17</b>	B6794MZ4	8HY-4775
<b>MZO17</b>	B6794MZ4	HY-4775
<b>MZO1794</b>	B1794MZ4	SHY-4775
<b>SU004</b>	B69178SU4	8HY-4792
<b>SU004</b>	B69178SU4	HY-4792
<b>SU019178</b>	B19178SU4	SHY-4792
<b>SU010</b>	B69339SU4	8HY-4793
<b>SU010</b>	B69339SU4	HY-4793
<b>SU019339</b>	B19339SU4	SHY-4793
<b>SU002</b>	B69177SU3	8HY-4794
<b>SU001</b>	B59177SU3	EL-4794
<b>SU019177</b>	B19177SU3	SEL-4794
<b>SU010</b>	B69339SU4	8HY-4795
<b>SU010</b>	B69339SU4	HY-4795
<b>SU019339</b>	B19339SU4	SHY-4795
<b>MZO22</b>	B69183MZ4	8HY-4881
<b>MZO22</b>	B69183MZ4	HY-4881
<b>MZO19183</b>	B19183MZ4	SHY-4881
<b>MZO24</b>	B69184MZ4	8HY-4882
<b>MZO24</b>	B69184MZ4	HY-4882
<b>MZO19184</b>	B19184MZ4	SHY-4882
<b>MZO37</b>	B69368MZ4	5SHY-4883
<b>GM0182</b>	B69127G4	8HY-4904
<b>GM0182</b>	B69127G4	HY-4904
<b>GM019127</b>	B19127G4	SHY-4904
<b>GM0180</b>	B69126G4	8HY-4905
<b>GM0180</b>	B69126G4	HY-4905
<b>GM019126</b>	B19126G4	SHY-4905
<b>GM0158</b>	B6972G4	8HY-4906
<b>GM0158</b>	B6972G4	HY-4906
<b>GM01972</b>	B1972G4	SEL-4906
<b>GM01972</b>	B1972G4	SHY-4906
<b>SZO10</b>	B69185SZ4	HY-4907

<b>SZO19185</b>	B19185SZ4	SHY-4907
<b>GM0158</b>	B6972G4	HY-4908
<b>GM01972</b>	B1972G4	SHY-4908
<b>GM0212</b>	B69186G4	HY-4909
<b>GM019186</b>	B19186G4	SHY-4909
<b>MI007</b>	B6755M4	8HY-4950
<b>MI007</b>	B6755M4	HY-4950
<b>MI01755</b>	B1755M4	SHY-4950
<b>VW039</b>	B6357W5	8HY-5010
<b>VW038</b>	B5357W5	C-5010
<b>VW039</b>	B6357W5	HY-5010
<b>NI092</b>	B69360N6	HY-6069
<b>NI019360</b>	B19360N6	SHY-6069
<b>NI056</b>	B6785N6	8HY-6070
<b>NI040</b>	B5785N6	8JG-6070
<b>NI056</b>	B6785N6	HY-6070
<b>NI040</b>	B5785N6	JG-6070
<b>NI01785</b>	B1785N6	SHY-6070
<b>NI064</b>	B6536N6	8HY-6072
<b>NI064</b>	B6536N6	HY-6072
<b>NI046</b>	B5536N6	JG-6072
<b>NI01536</b>	B1536N6	SHY-6072
<b>NI075</b>	B69225N6	HY-6075
<b>NI019225</b>	B19225N6	SHY-6075
<b>NI071</b>	B69115N6	HY-6076
<b>NI019115</b>	B19115N6	SHY-6076
<b>FO0205</b>	B69275F6	HY-6077
<b>FO019275</b>	B19275F6	SHY-6077
<b>HY030</b>	B69301HY6	HY-6086
<b>HY019301</b>	B19301HY6	SHY-6086
<b>TY018</b>	B6822Y6	8HY-6257
<b>TY018</b>	B6822Y6	SEL-6257
<b>TY018</b>	B6822Y6	8HY-6312
<b>TY018</b>	B6822Y6	HY-6312
<b>TY01822</b>	B1822Y6	SHY-6312
<b>TY057</b>	B69345Y4	HY-6318
<b>TY019345</b>	B19345Y4	SHY-6318
<b>TY021</b>	B69116Y6	5SHY-6319
<b>TY022</b>	B69119Y6	5SHY-6325
<b>MZO28</b>	B69232MZ6	8HY-6399
<b>MZO28</b>	B69232MZ6	HY-6399
<b>MZO19232</b>	B19232MZ6	SHY-6399
<b>CH0105</b>	B69269C6	HY-6412
<b>CH019269</b>	B19269C6	SHY-6412
<b>IS008</b>	B69140I6	HY-6500
<b>IS019140</b>	B19140I6	SHY-6500
<b>MI016</b>	B69141M6	5HY-6511
<b>MI014</b>	B69122M6	5HY-6512
<b>CH070</b>	B6821C6	8HY-6540
<b>CH049</b>	B5821C6	8JG-6540
<b>CH070</b>	B6821C6	HY-6540
<b>CH01821</b>	B1821C6	SHY-6540
<b>HN016</b>	B69207HN6	HY-6700
<b>HN019207</b>	B19207HN6	SHY-6700
<b>HN007</b>	B6981HN6	HY-6701
<b>HN01981</b>	B1981HN6	SHY-6701
<b>LRO02</b>	B69329LR8	8HY-8081
<b>LRO01</b>	B59329LR8	8JG-8081
<b>LRO02</b>	B69329LR8	HY-8081
<b>LRO01</b>	B59329LR8	JG-8081
<b>LRO19329</b>	B19329LR8	SHY-8081
<b>LRO04</b>	B69330LR8	8HY-8085
<b>LRO04</b>	B69330LR8	HY-8085
<b>LRO19330</b>	B19330LR8	SEL-8085
<b>LRO19330</b>	B19330LR8	SHY-8085
<b>FO095</b>	B6100F8	BOOT 1003
<b>FO096</b>	B6101F8	BOOT 1006
<b>GM090</b>	B6102G4	BOOT 1008
<b>CH094</b>	B6105C4	BOOT 1004
<b>FO0183</b>	B6106F6	BOOT 1005
<b>CH095</b>	B6107C6	BOOT 1002
<b>GM0281</b>	B6108G4	BOOT 1001
<b>GM0235</b>	B6112G6	BOOT 1007
<b>FO0208</b>	B6113F4	BOOT 1009
<b>CH0108</b>	B6114C8	BOOT 1010

\* La información indicada en esta publicación, ha sido obtenida por fuentes confiables y oficiales, consideramos que los datos contenidos en esta publicación, son propiedad de sus titulares, Cromios SA de CV, no se hace responsable por los cambios de titularidad de los registros de marca a la fecha de la presente publicación, SEPTIEMBRE 2013"



# CAHSA vs KEM

		KEM			KEM			KEM
CH01702	B1702C8	CB-102	FO01977	B1977F6	CB-188	CH01965	B1965C4	CB-266
CH01300	B1300C6	CB-103	GM01964	B1964G4	CB-189	CH01985	B1985C6	CB-267
CH01750	B1750C4	CB-104	VW064	B6936W4	CB-190	FO01938	B19138F6	CB-268
CH01790	B1790C8	CB-105	FO01815	B1815F8	CB-191	CH019304	B19304C4	CB-269
FO01700	B1700F6	CB-106	CH01842	B1842C6	CB-192	GM01927	B1927G4	CB-270
FO01780	B1780F4	CB-107	GM01828	B1828G4	CB-193	GM01534	B1534G8	CB-271
FO01200	B1200F8	CB-108	FO01836	B1836F6	CB-194	FO01706	B1706F8	CB-272
FO01757	B1757F6	CB-109	FO01734	B1734F6	CB-195	FO019105	B19105F4	CB-273
GM01741	B1741G6	CB-110	FO01974	B1974F6	CB-196	DW019104	B19104D4	CB-274
GM01740	B1740G6	CB-111	FO01973	B1973F6	CB-197	FO01751	B1751F6	CB-275
GM01720	B1720G8	CB-112	FO01836	B1836F6	CB-198	GM019136	B19136G4	CB-276
GM01710	B1710G6	CB-113	FO01912	B1912F4	CB-199	FO019106	B19106F6	CB-277
GM01719	B1719G6	CB-114	FO01978	B1978F8	CB-200	VW067	B69113W4	CB-278
GM01270	B1270G6	CB-115	NI01536	B1536N6	CB-201	VW067	B69113W4	CB-279
NI01400	B1400N4	CB-116	NI01982	B1982N4	CB-202	GM01957	B1957G8	CB-280
NI01230	B1230N4	CB-117	NI019115	B19115N6	CB-203	CH01984	B1984C8	CB-287
NI01500	B1500N4	CB-118	HNO1979	B1979HN4	CB-204	PG019356	B19356PG4	CB-288
NI01711	B1711N4	CB-119	HNO1980	B1980HN4	CB-205	FO01717	B1717F8	CB-290
VW01360	B1360W4	CB-120	HNO1814	B1814HN4	CB-206	VW067	B69113W4	CB-291
VW01340	B1340W4	CB-121	HNO1981	B1981HN6	CB-207	GM019161	B19161G4	CB-292
VA01250	B1250V6	CB-129	GM01971	B1971G6	CB-208	NI019276	B19276N4	CB-293
GM01730	B1730G8	CB-130	GM01996	B1996G8	CB-209	GM019219	B19219G8	CB-294
GM01534	B1534G8	CB-131	GM01995	B1995G8	CB-210	MC019142	B19142MC4	CB-295
FO01769	B1769F8	CB-132	GM01915	B1915G8	CB-211	GM019221	B19221G6	CB-296
FO01746	B1746F4	CB-134	GM01929	B1929G4	CB-212	FT019370	B19370FT4	CB-299
GM01280	B1280G8	CB-135	CH01334	B1334C4	CB-213	GM019167	B19167G4	CB-300
FO01747	B1747F8	CB-136	GM019386	B19386G4	CB-214	GM019391	B19391G8	CB-302
FO01744	B1744F8	CB-137	HY01779	B1779HY4	CB-215	FO0208	B6113F4	CH-02
CH01703	B1703C8	CB-138	GM01952	B1952G6	CB-216	FO095	B6100F8	CH-04
CH01791	B1791C6	CB-139	GM01993	B1993G6	CB-217	GM0281	B6108G4	CH-05
FO01724	B1724F8	CB-140	GM01994	B1994G6	CB-218	CH0108	B6114C8	CH-06
NI01402	B1402N4	CB-141	FO01913	B1913F4	CB-219	GM090	B6102G4	CH-07
CH01334	B1334C4	CB-142	NI01532	B1532N4	CB-220	CH094	B6105C4	CH-20
GM01742	B1742G4	CB-143	FO01858	B1858F6	CB-221	CH095	B6107C6	CH-21
FO01716	B1716F8	CB-144	FO01950	B1950F6	CB-222	FO0183	B6106F6	CH-22
NI01531	B1531N4	CB-145	GM01830	B1830G4	CB-223	GM0235	B6112G6	CH-23
NI01500	B1500N4	CB-146	GM01968	B1968G6	CB-224	FO096	B6101F8	CH-40
NI01530	B1530N4	CB-147	GM01829	B1829G6	CB-225	NI048	B6117N4	CH-60
GM01729	B1729G4	CB-148	FO01717	B1717F8	CB-226	VW016	B5360W4	L-1118
NI01233	B1233N4	CB-149	FO01705	B1705F8	CB-227	VW015	B5340W4	L-1119
NI01402	B1402N4	CB-150	FO01951	B1951F6	CB-228	VW016	B5360W4	L-1120
FO019377	B19377F4	CB-151	FO01833	B1833F4	CB-229	VW015	B5340W4	L-1121
FO01708	B1708F6	CB-152	VW050	B6962W4	CB-230	VW021	B5745W4	L-1122
FO01827	B1827F6	CB-153	GM01829	B1829G6	CB-231	VW024	B5765W4	L-1123
CH01712	B1712C4	CB-154	GM01856	B1856G6	CB-232	VW026	B5762W4	L-1124
CH01736	B1736C6	CB-155	NI01914	B19114N6	CB-233	VW026	B5762W4	L-1125
CH01333	B1333C4	CB-156	FO019129	B19129F6	CB-233	ST002	B6938ST4	L-1150
CH01743	B1743C6	CB-157	GM01999	B1999G8	CB-234	VW031	B5351W4	L-1159
FO01718	B1718F6	CB-158	GM01954	B1954G8	CB-235	VW033	B5353W4	L-1160
VW053	B6351W4	CB-159	GM019383	B19383G8	CB-236	VW028	B5934W4	L-1161
VW055	B6353W4	CB-160	FO01990	B1990F4	CB-237	VW034	B5354W4	L-1162
VW062	B6934W4	CB-161	FO01937	B1937F4	CB-238	VW029	B5935W4	L-1165
VW037	B6354W4	CB-162	FO01991	B1991F4	CB-239	VW050	B6962W4	L-1170
FO01601	B1601F6	CB-163	ST002	B6938ST4	CB-240	VW067	B69113W4	L-1171
FO01735	B1735F6	CB-164	FO019378	B19378F4	CB-241	VW027	B5933W4	L-1172
VW063	B6935W4	CB-165	NI01537	B1537N4	CB-242	VW067	B69113W4	L-1173
GM01726	B1726G6	CB-166	FO01827	B1827F6	CB-243	VW066	B59113W4	L-1174
FO01739	B1739F8	CB-167	TY01721	B1721Y4	CB-244	VW040	B5936W4	L-1190
FO01738	B1738F6	CB-168	MZ01832	B1832MZ4	CB-245	VW039	B6357W5	L-1274
FO01725	B1725F8	CB-169	VW039	B6357W5	CB-246	VW042	B6945W6	L-1275
FO01727	B1727F8	CB-170	GM01911	B1911G4	CB-247	NI036	B6530N4	L-2101
FO01728	B1728F8	CB-171	NI019380	B19380N6	CB-248	NI035	B6233N4	L-2102
VW061	B6933W4	CB-172	NI019100	B19100N4	CB-249	NI055	B6532N4	L-2103
FO01751	B1751F6	CB-173	GM01952	B1952G6	CB-250	NI052	B6982N4	L-2104
FO01737	B1737F4	CB-174	GM01993	B1993G6	CB-251	NI008	B6500N4	L-2105
CH01825	B1825C6	CB-175	GM01971	B1971G6	CB-252	NI028	B6402N4	L-2106
GM019384	B19384G6	CB-176	GM019137	B19137G6	CB-253	NI025	B6531N4	L-2107
CH01908	B1908C6	CB-177	VW042	B6945W6	CB-254	NI067	B69100N4	L-2108
CH01782	B1782C8	CB-178	FO01976	B1976F6	CB-255	NI050	B6537N4	L-2109
CH01783	B1783C6	CB-179	FO01992	B1992F6	CB-256	NI035	B6233N4	L-2110
GM019379	B19379G6	CB-180	GM01952	B1952G6	CB-257	NI052	B6982N4	L-2112
GM01916	B1916G6	CB-181	CH01983	B1983C8	CB-258	NI022	B6221N8	L-2113
GM01545	B1545G6	CB-182	FO01975	B1975F6	CB-259	NI014	B5500N4	L-2117
GM01997	B1997G8	CB-183	FO01978	B1978F8	CB-260	NI014	B5500N4	L-2118
FO01754	B1754F4	CB-184	CH01985	B1985C6	CB-261	NI020	B5711N4	L-2119
FO01826	B1826F4	CB-185	FO019135	B19135F4	CB-263	NI020	B5711N4	L-2120
GM019385	B19385G6	CB-186	FO01937	B1937F4	CB-264	NI018	B5402N4	L-2141
FO019132	B19132F6	CB-187	FO019112	B19112F6	CB-265	NI018	B5402N4	L-2142







\*Importante: La información indicada en esta publicación, ha sido obtenida por fuentes confiables y oficiales, consideramos que es correcta, sin embargo no asumimos ninguna responsabilidad por errores, cambios, omisiones o datos que resultaran de estos.





# CAHSA vs LODI

\*Importante: La información indicada en esta publicación, ha sido obtenida por fuentes confiables y oficiales, consideramos que es correcta, sin embargo no asumimos ninguna responsabilidad por errores, cambios, omisiones o datos que resultaran de estos.



		LODI			LODI			LODI
CH028	B5334C4	C-7D2.0	VW035	B5355W4	C-7WW1800CM	GM0197	B59163G6	C-EG173E
CH012	B5750C4	C-7D2.2	VW049	B5962W4	C-7WW2.0	GM0239	B59255G6	C-EG173ZF
CH026	B5333C4	C-7D2.4	VW021	B5745W4	C-7WVE1600	GM033	B5742G4	C-EG2.2
CH017	B5543C4	C-7D2.5L	VW032	B5352W4	C-7WVE1600EO	GM072	B5282G4	C-EG2.2A
CH059	B5857C4	C-7D2.6	VW045	B8352W4	C-7WVE1600EO	ES007	B5203G4	C-EG2.5
CH014	B5301C6	C-7D225	GM0281	B6108G4	CA-002	GM044	B5715G6	C-EG2.8
CH061	B5841C6	C-7D3.0	CH095	B6107C6	CA-003	GM028	B5740G6	C-EG2.8P
CH031	B5736C6	C-7D3.3L	FO095	B6100F8	CA-004	GM063	B5726G6	C-EG231
CH034	B5743C6	C-7D3.5L	CH094	B6105C4	CA-005	GM025	B5270G6	C-EG250
CH018	B5791C6	C-7D3.9L	FO0183	B6106F6	CA-006	GM029	B5710G6	C-EG250E
CH015	B5790C8	C-7D360	FO096	B6101F8	CA-007	GM071	B5545G6	C-EG250N
CH024	B5703C8	C-7D360FI	GM0235	B6112G6	CA-008	GM053	B5719G6	C-EG3.1
ES001	B5202F4	C-7F1.6L	GM090	B6102G4	CA-009	GM078	B5829G6	C-EG3.1A
FO034	B5714F4	C-7F110	FO0208	B6113F4	CA-010	GM032	B5741G6	C-EG3.1S
FO049	B5761F4	C-7F140	CH0108	B6114C8	CA-011	GM0295	B59384G6	C-EG3.2
FO052	B5880F4	C-7F140E	CH028	B5334C4	C-ED2.0	GM0103	B5846G6	C-EG3.4L
FO0104	B5844F6	C-7F232E	CH012	B5750C4	C-ED2.2	GM0135	B5952G6	C-EG3.8
FO033	B5708F6	C-7F232FI	CH017	B5543C4	C-ED2.5L	GM026	B5280G8	C-EG350
FO0108	B5854F6	C-7F300E	CH059	B5857C4	C-ED2.6	GM097	B5917G8	C-EG350A
FO015	B5200F8	C-7F302	CH014	B5301C6	C-ED225	GM030	B5720G8	C-EG350E
FO031	B5706F8	C-7F400E	CH061	B5841C6	C-ED3.0	GM038	B5731G8	C-EG350EL
FO030	B5705F8	C-7F400EC	CH055	B5842C6	C-ED3.0A	GM0251	B59261G8	C-EG350ELR
FO027	B5784F8	C-7F400EL	CH031	B5736C6	C-ED3.3L	GM0251	B59261G8	C-EG350ELR
GM042	B5704G4	C-7G1.8A	CH048	B5820C6	C-ED3.9	GM037	B5544G8	C-EG350LTBI
GM045	B5713G4	C-7G1.8B	CH018	B5791C6	C-ED3.9L	GM0159	B5989G8	C-EG350LTBIR
GM0115	B5927G4	C-7G1.8C	CH015	B5790C8	C-ED360	GM035	B5756G8	C-EG350TBI
GM0197	B59163G6	C-7G173E	CH024	B5703C8	C-ED360FI	GM069	B5810G8	C-EG350TBIR
GM033	B5742G4	C-7G2.2	CH084	B5987C6	C-ED4.0	GM0243	B59257G6	C-EG4.3
GM028	B5740G6	C-7G2.8P	FO080	B5754F4	C-EF1.3	GM0153	B5968G6	C-EG4.3A
GM025	B5270G6	C-7G250	FO091	B5912F4	C-EF1.6	GM0143	B5956G8	C-EG454E
GM029	B5710G6	C-7G250E	ES001	B5202F4	C-EF1.6L	GM083	B5835G8	C-EG454EN
GM032	B5741G6	C-7G3.1S	FO0131	B5948F4	C-EF1.8	GM0116	B5928G8	C-EG5.7
GM078	B5829G6	C-7G3.1T	FO034	B5714F4	C-EF110	GM0137	B5953G8	C-EG5.9
GM026	B5280G8	C-7G350	FO049	B5761F4	C-EF140	GM097	B5917G8	C-EG7.4
GM030	B5720G8	C-7G350E	FO118	B5780F4	C-EF140"O"	MZ007	B5816M24	C-EM2.0L
GM038	B5731G8	C-7G350EL	FO052	B5880F4	C-EF140E	MZ009	B5818M24	C-EM2.2L
MZ007	B5816M24	C-7M2.0L	FO023	B5746F4	C-EF140FI	MZ025	B59233M26	C-EM3.0
MZ009	B5818M24	C-7M2.2L	FO019	B5700F6	C-EF171	CH022	B5753C4	C-EMT2.6L
CH022	B5753C4	C-7MT2.6L	FO093	B5913F4	C-EF2.0	NIO81	B59348N4	C-EN1.6
MZ002	B5758M24	C-7MT2.6L	FO046	B5737F4	C-EF2.0L	NIO12	B5220N4	C-EN1500
NIO12	B5220N4	C-7N1500	FO085	B5826F4	C-EF2.0M	NIO15	B5390N4	C-EN1600
NIO15	B5390N4	C-7N1600	FO090	B5833F4	C-EF2.3L	NIO18	B5402N4	C-EN1600EO
NIO18	B5402N4	C-7N1600EO	FO086	B5815F8	C-EF2.3LBD	NIO11	B5400N4	C-EN1600III
NIO11	B5400N4	C-7N1600EOL	FO043	B5718F6	C-EF2.5L	NIO14	B5500N4	C-EN1800
NIO11	B5400N4	C-7N1600III	FO088	B5827F6	C-EF2.8	NIO21	B5221N8	C-EN2.0D
NIO14	B5500N4	C-7N1800	FO088	B5827F6	C-EF2.9	NIO16	B5224N4	C-EN2.0L
NIO21	B5221N8	C-7N2.0D	FO021	B5201F6	C-EF200	NIO16	B5224N4	C-EN2.0S
NIO16	B5224N4	C-7N2.0L	FO0104	B5844F6	C-EF232E	NIO17	B5233N4	C-EN2.4F
NIO16	B5224N4	C-7N2.0S	FO033	B5708F6	C-EF232FI	NIO17	B5233N4	C-EN2.4LE
NIO17	B5233N4	C-7N2.4F	FO0104	B5844F6	C-EF232M	NIO19	B5231N8	C-ENZ24
NIO17	B5233N4	C-7N2.4LE	FO0100	B5836F6	C-EF244	RE014	B5240R4	C-ER1300
NIO19	B5231N8	C-7NZ24	FO088	B5827F6	C-EF3.0L	RE017	B5524R4	C-ER2000
RE014	B5240R4	C-7R1300	FO045	B5735F6	C-EF3.8C	VA005	B5250V6	C-ER258
RE017	B5524R4	C-7R2000	FO025	B5748F6	C-EF3.8FI	RE020	B5768R4	C-ERA1400
VA005	B5250V6	C-7R258	FO078	B5751F6	C-EF3.8L	RE016	B5380R4	C-ERA1700
RE020	B5768R4	C-7RA1400	FO0108	B5854F6	C-EF300E	TY001	B5721Y4	C-ETY22R
RE016	B5380R4	C-7RA1700	FO015	B5200F8	C-EF302	TY004	B5723Y4	C-ETY22RL
TY001	B5721Y4	C-7TY22R	FO024	B5747F8	C-EF302FI	TY008	B5822Y6	C-ETYV6
TY004	B5723Y4	C-7TY22RL	FO035	B5717F8	C-EF351FI	ES008	B5813FG8	C-EU8E
UN023	B5310U4	C-7U4	FO0184	B59139F8	C-EF370	HY006	B6779HY4	C-P7D1.0
UN024	B5320U6	C-7U6	FO0175	B59132F6	C-EF4.0	CH029	B6334C4	C-P7D2.0
UN025	B5330U8	C-7U8	FO0145	B5975F6	C-EF4.0N	CH008	B6750C4	C-P7D2.2
VW066	B59113W4	C-7WW1.6	FO0135	B5950G6	C-EF4.2	CH027	B6333C4	C-P7D2.4
VW015	B5340W4	C-7WW1600	FO0135	B5950G6	C-EF4.2G	CH064	B6965C4	C-P7D2.4L
VW025	B8340W4	C-7WW1600B	FO042	B5716F8	C-EF4.6LFI	CH071	B6825C6	C-P7D2.5
VW016	B5360W4	C-7WW1600C	FO031	B5706F8	C-EF400E	CH068	B6543C4	C-P7D2.5L
VW033	B5353W4	C-7WW1600CB	FO030	B5705F8	C-EF400EC	CH053	B6907C4	C-P7D2.5N
VW003	B8342W4	C-7WW1600CM	FO027	B5784F8	C-EF400EL	CH060	B6857C4	C-P7D2.6
VW032	B5352W4	C-7WW1600EO88	FO022	B5744F8	C-EF5.0LFI	CH010	B6301C6	C-P7D225
VW001	B8341W4	C-7WW1600EO88	FO035	B5717F8	C-EF5.8	CH062	B6841C6	C-P7D3.0
VW027	B5933W4	C-7WW1600FI	GM0179	B59126G4	C-EG1.3	CH037	B6736C6	C-P7D3.3L
VW041	B8947W4	C-7WW1600FI	ES007	B5203G4	C-EG1.8	CH038	B6743C6	C-P7D3.5L
VW001	B8341W4	C-7WW1600-O	GM042	B5704G4	C-EG1.8A	CH081	B6985C6	C-P7D3.8
VW036	B5356W4	C-7WW1800B	GM045	B5713G4	C-EG1.8B	CH097	B69160C6	C-P7D3.8L



<b>CH069</b>	B6820C6	C-P7D3.9
<b>CH019</b>	B6791C6	C-P7D3.9L
<b>CH011</b>	B6790C8	C-P7D360
<b>CH040</b>	B6703C8	C-P7D360FI
<b>CH054</b>	B6908C6	C-P7D4.07
<b>CH0103</b>	B69236C8	C-P7D5.7
<b>CH079</b>	B6983C8	C-P7DDAKOTA
<b>HY009</b>	B6778HY4	C-P7DH-100
<b>FO050</b>	B6202F4	C-P7F1.6L
<b>FO0123</b>	B6714F4	C-P7F110
<b>FO0126</b>	B6761F4	C-P7F140
<b>FO059</b>	B6737F4	C-P7F2.0L
<b>FO010</b>	B6200F8	C-P7F302
<b>FO098</b>	B6717F8	C-P7F351FI
<b>FO0115</b>	B6937F4	C-P7FK
<b>GM0180</b>	B69126G4	C-P7G1.3L
<b>GM0122</b>	B6704G4	C-P7G1.8A
<b>GM0123</b>	B6713G4	C-P7G1.8B
<b>GM0120</b>	B6927G4	C-P7G1.8C
<b>GM0158</b>	B6972G4	C-P7G16V
<b>GM0276</b>	B69325G4	C-P7G2.0
<b>GM024</b>	B6742G4	C-P7G2.2
<b>GM019</b>	B6740G6	C-P7G2.8P
<b>GM016</b>	B6270G6	C-P7G250
<b>GM023</b>	B6741G6	C-P7G3.1S
<b>GM084</b>	B6829G6	C-P7G3.1T
<b>GM0164</b>	B6994G6	C-P7G3.8A
<b>GM050</b>	B6280G8	C-P7G350
<b>GM021</b>	B6720G8	C-P7G350E
<b>GM0162</b>	B6993G6	C-P7G4.3V
<b>GM0170</b>	B6997G8	C-P7G5.7A
<b>GM0140</b>	B6954G8	C-P7G8.1
<b>GM0224</b>	B69219G8	C-P7G8.1N
<b>GM0276</b>	B69325G4	C-P7GASTRA
<b>GM0206</b>	B69167G4	C-P7GAVEO
<b>GM089</b>	B6911G4	C-P7GCHEVY
<b>GM0232</b>	B69230G8	C-P7GDORADO
<b>DW017</b>	B69104D4	C-P7GMATIZ
<b>HN003</b>	B6979HN4	C-P7H1.6
<b>HN016</b>	B69207HN6	C-P7H2.7
<b>HN007</b>	B6981HN6	C-P7H3.0
<b>IS008</b>	B69140I6	C-P7IRODEO
<b>MZ018</b>	B6816MZ4	C-P7M2.0L
<b>MZ012</b>	B6818MZ4	C-P7M2.2L
<b>MZ011</b>	B6817MZ4	C-P7M2.4L
<b>MZ014</b>	B6758MZ4	C-P7M2.6L
<b>MZ026</b>	B69233MZ6	C-P7M3.0
<b>MZ028</b>	B69232MZ6	C-P7M3.0L
<b>CH073</b>	B6753C4	C-P7MT2.6L
<b>NIO34</b>	B6220N4	C-P7N1500
<b>NIO63</b>	B6390N4	C-P7N1600
<b>NIO28</b>	B6402N4	C-P7N1600EO
<b>NIO10</b>	B6400N4	C-P7N1600III
<b>NIO25</b>	B6531N4	C-P7N16V
<b>NIO08</b>	B6500N4	C-P7N1800
<b>NIO22</b>	B6221N8	C-P7N2.0D
<b>NIO62</b>	B6224N4	C-P7N2.0L
<b>NIO62</b>	B6224N4	C-P7N2.0S
<b>NIO67</b>	B69100N4	C-P7N2.4
<b>NIO52</b>	B6982N4	C-P7N2.4
<b>NIO75</b>	B69225N6	C-P7N2.4B
<b>NIO35</b>	B6233N4	C-P7N2.4F
<b>NIO35</b>	B6233N4	C-P7N2.4LE
<b>NIO67</b>	B69100N4	C-P7N2.4U
<b>NIO69</b>	B69114N6	C-P7N3.0
<b>NIO71</b>	B69115N6	C-P7N3.3
<b>NIO31</b>	B6231N8	C-P7NZ24
<b>RE022</b>	B6240R4	C-P7R1300
<b>RE025</b>	B6524R4	C-P7R2000
<b>VA006</b>	B6250V6	C-P7R258
<b>RE021</b>	B6768R4	C-P7RA1400
<b>TY013</b>	B6721Y4	C-P7TY22R
<b>TY015</b>	B6723Y4	C-P7TY22RL
<b>VW012</b>	B6340W4	C-P7VW1600
<b>VW013</b>	B6360W4	C-P7VW1600C
<b>ST002</b>	B6938S4	C-P7VW2.0L
<b>CH008</b>	B6750C4	C-PD2.2
<b>CH068</b>	B6543C4	C-PD2.5L
<b>CH010</b>	B6301C6	C-PD225
<b>CH062</b>	B6841C6	C-PD3.0



<b>CH069</b>	B6820C6	C-PD3.9
<b>CH019</b>	B6791C6	C-PD3.9L
<b>CH019</b>	B6791C6	C-PD3.9LFI
<b>CH011</b>	B6790C8	C-PD360
<b>CH040</b>	B6703C8	C-PD360FI
<b>CH079</b>	B6983C8	C-PD360TBI
<b>CH085</b>	B6987C6	C-PD4.0
<b>CH044</b>	B6782C8	C-PD5.2L
<b>CH093</b>	B69123C10	C-PD8.0L
<b>FO081</b>	B6754F4	C-PF1.3
<b>FO092</b>	B6912F4	C-PF1.6
<b>FO050</b>	B6202F4	C-PF1.6L
<b>FO0132</b>	B6948F4	C-PF1.8
<b>FO0187</b>	B69168F6	C-PF12V
<b>FO0126</b>	B6761F4	C-PF140
<b>FO060</b>	B6880F4	C-PF140"O"
<b>FO099</b>	B6746F4	C-PF140E
<b>FO013</b>	B6780F4	C-PF140FI
<b>FO0160</b>	B69105F4	C-PF16V
<b>FO014</b>	B6700F6	C-PF171
<b>FO094</b>	B6913F4	C-PF2.0
<b>FO0160</b>	B69105F4	C-PF2.0C
<b>FO059</b>	B6737F4	C-PF2.0L
<b>FO0127</b>	B6826F4	C-PF2.0M
<b>FO0130</b>	B6833F4	C-PF2.3L
<b>FO087</b>	B6815F8	C-PF2.3LBD
<b>FO063</b>	B6718F6	C-PF2.5L
<b>FO0128</b>	B6827F6	C-PF2.9
<b>FO036</b>	B6201F6	C-PF200
<b>FO0105</b>	B6844F6	C-PF232E
<b>FO097</b>	B6708F6	C-PF232FI
<b>FO0105</b>	B6844F6	C-PF232M
<b>FO0101</b>	B6836F6	C-PF244
<b>FO0142</b>	B6973F6	C-PF24V
<b>FO0144</b>	B6974F6	C-PF3.0C
<b>FO0128</b>	B6827F6	C-PF3.0L
<b>FO0158</b>	B6992F6	C-PF3.8
<b>FO066</b>	B6735F6	C-PF3.8C
<b>FO0117</b>	B6748F6	C-PF3.8FI
<b>FO079</b>	B6751F6	C-PF3.8L
<b>FO0158</b>	B6992F6	C-PF3.8M
<b>FO079</b>	B6751F6	C-PF3.8N
<b>FO0109</b>	B6854F6	C-PF300E
<b>FO010</b>	B6200F8	C-PF302
<b>FO0116</b>	B6747F8	C-PF302FI
<b>FO098</b>	B6717F8	C-PF351FI
<b>FO0185</b>	B69139F8	C-PF370
<b>FO0176</b>	B69132F6	C-PF4.0
<b>FO0146</b>	B6975F6	C-PF4.0N
<b>FO0136</b>	B6950F6	C-PF4.2G
<b>FO0148</b>	B6976F6	C-PF4.2L
<b>FO076</b>	B6716F8	C-PF4.6LFI
<b>FO0122</b>	B6706F8	C-PF400E
<b>FO0121</b>	B6705F8	C-PF400EC
<b>FO0119</b>	B6784F8	C-PF400EL
<b>FO070</b>	B6725F8	C-PF5.0
<b>FO074</b>	B6744F8	C-PF5.0LFI
<b>FO0193</b>	B69171F8	C-PF5.0N
<b>FO0162</b>	B69106F6	C-PFMONDEO
<b>FO0191</b>	B69170F6	C-PFSABLE
<b>GM061</b>	B6203G4	C-PG1.8
<b>GM0122</b>	B6704G4	C-PG1.8A
<b>GM0123</b>	B6713G4	C-PG1.8B
<b>GM0198</b>	B69163G6	C-PG173E
<b>GM0240</b>	B69255G6	C-PG173ZF
<b>GM0276</b>	B69325G4	C-PG2.0
<b>GM024</b>	B6742G4	C-PG2.2
<b>GM0119</b>	B6929G4	C-PG2.2C
<b>GM061</b>	B6203G4	C-PG2.5
<b>GM085</b>	B6830G4	C-PG2.5N
<b>GM0100</b>	B6715G6	C-PG2.8
<b>GM019</b>	B6740G6	C-PG2.8P
<b>GM064</b>	B6726G6	C-PG231
<b>GM016</b>	B6270G6	C-PG250
<b>GM020</b>	B6710G6	C-PG250E
<b>GM0129</b>	B6545G6	C-PG250N
<b>GM062</b>	B6719G6	C-PG3.1
<b>GM023</b>	B6741G6	C-PG3.1S
<b>GM084</b>	B6829G6	C-PG3.1T
<b>GM0286</b>	B69384G6	C-PG3.2

<b>GM0136</b>	B6952G6	C-PG3.8
<b>GM050</b>	B6280G8	C-PG350
<b>GM021</b>	B6720G8	C-PG350E
<b>GM039</b>	B6731G8	C-PG350EL
<b>GM0252</b>	B69261G8	C-PG350ELR
<b>GM099</b>	B6544G8	C-PG350LTBI
<b>GM0160</b>	B6989G8	C-PG350LTBIR
<b>GM0121</b>	B6756G8	C-PG350TBI
<b>GM070</b>	B6810G8	C-PG350TBIR
<b>ES009</b>	B6813FG8	C-PG350TBIR
<b>GM0244</b>	B69257G6	C-PG4.3
<b>GM0154</b>	B6968G6	C-PG4.3A
<b>GM0134</b>	B6941G6	C-PG4.3L
<b>GM0144</b>	B6956G8	C-PG454E
<b>GM0117</b>	B6928G8	C-PG5.7
<b>GM098</b>	B6917G8	C-PG5.7C
<b>GM0138</b>	B6953G8	C-PG5.9
<b>GM098</b>	B6917G8	C-PG7.4
<b>GM0140</b>	B6954G8	C-PG8.1
<b>GM089</b>	B6911G4	C-PGCHEVY
<b>GM0286</b>	B69384G6	C-PGZTEC
<b>MZ018</b>	B6816MZ4	C-PM2.0L
<b>MZ012</b>	B6818MZ4	C-PM2.2L
<b>CH073</b>	B6753C4	C-PMT2.6L
<b>NIO34</b>	B6220N4	C-PN1500
<b>NIO63</b>	B6390N4	C-PN1600
<b>NIO28</b>	B6402N4	C-PN1600EO
<b>NIO10</b>	B6400N4	C-PN1600III
<b>NIO25</b>	B6531N4	C-PN16V
<b>NIO08</b>	B6500N4	C-PN1800
<b>NIO22</b>	B6221N8	C-PN2.0D
<b>NIO62</b>	B6224N4	C-PN2.0L
<b>NIO62</b>	B6224N4	C-PN2.0S
<b>NIO35</b>	B6233N4	C-PN2.4
<b>NIO35</b>	B6233N4	C-PN2.4F
<b>NIO35</b>	B6233N4	C-PN2.4LE
<b>NIO31</b>	B6231N8	C-PNZ24
<b>RE022</b>	B6240R4	C-PR1300
<b>VA006</b>	B6250V6	C-PR258
<b>TY013</b>	B6721Y4	C-PTY22R
<b>TY015</b>	B6723Y4	C-PTY22RL
<b>ES009</b>	B6813FG8	C-PU8E
<b>VW013</b>	B6360W4	C-PWV1600C
<b>HY01779</b>	B1779HY4	C-S7D1.0
<b>CH01334</b>	B1334C4	C-S7D2.0
<b>CH01750</b>	B1750C4	C-S7D2.2
<b>CH01333</b>	B1333C4	C-S7D2.4
<b>CH01825</b>	B1825C6	C-S7D2.5
<b>CH01543</b>	B1543C4	C-S7D2.5L
<b>CH01857</b>	B1857C4	C-S7D2.6
<b>CH01301</b>	B1301C6	C-S7D225
<b>CH01736</b>	B1736C6	C-S7D3.3L
<b>CH01743</b>	B1743C6	C-S7D3.5L
<b>CH01791</b>	B1791C6	C-S7D3.9L
<b>CH01790</b>	B1790C8	C-S7D360
<b>CH01703</b>	B1703C8	C-S7D360FI
<b>FO01761</b>	B1761F4	C-S7F140
<b>FO01200</b>	B1200F8	C-S7F302
<b>FO01717</b>	B1717F8	C-S7F351FI
<b>GM01203</b>	B1203G4	C-S7G1.8
<b>GM01713</b>	B1713G4	C-S7G1.8B
<b>GM01742</b>	B1742G4	C-S7G2.2
<b>GM01740</b>	B1740G6	C-S7G2.8P
<b>GM01270</b>	B1270G6	C-S7G250
<b>GM01741</b>	B1741G6	C-S7G3.1S
<b>GM01280</b>	B1280G8	C-S7G350
<b>GM01954</b>	B1954G8	C-S7G8.1
<b>GM019219</b>	B19219G8	C-S7G8.1N
<b>GM019325</b>	B19325G4	C-S7GASTRA
<b>GM019167</b>	B19167G4	C-S7GAVEO
<b>GM01911</b>	B1911G4	C-S7GCHEVY
<b>MZ01816</b>	B1816MZ4	C-S7M2.0L
<b>MZ01818</b>	B1818MZ4	C-S7M2.2L
<b>CH01753</b>	B1753C4	C-S7MT2.6L
<b>NIO1390</b>	B1390N4	C-S7N1600
<b>NIO1400</b>	B1400N4	C-S7N1600III
<b>NIO1531</b>	B1531N4	C-S7N16V
<b>NIO1500</b>	B1500N4	C-S7N1800
<b>NIO1224</b>	B1224N4	C-S7N2.0S
<b>NIO1233</b>	B1233N4	C-S7N2.4F







		LODI
NI019100	B19100N4	C-S7N2.4U
RE01524	B1524R4	C-S7R2000
VA01250	B1250V6	C-S7RA1400
TY01721	B1721Y4	C-S7TY22R
VW012	B6340W4	C-S7VW1600
VW013	B6360W4	C-S7VW1600C
CH01791	B1791C6	C-SD3.9L
CH01703	B1703C8	C-SD360FI
CH01987	B1987C6	C-SD4.0
FO01754	B1754F4	C-SF1.3
FO01202	B1202F4	C-SF1.6L
FO01948	B1948F4	C-SF1.8
FO01880	B1880F4	C-SF140E
FO01746	B1746F4	C-SF140FI
FO01700	B1700F6	C-SF171
FO01913	B1913F4	C-SF2.0
FO01737	B1737F4	C-SF2.0L
FO01826	B1826F4	C-SF2.0M
FO01833	B1833F4	C-SF2.3L
FO01815	B1815F8	C-SF2.3LBD
FO01718	B1718F6	C-SF2.5L
FO01827	B1827F6	C-SF2.9
FO01201	B1201F6	C-SF200
FO01844	B1844F6	C-SF232E
FO01708	B1708F6	C-SF232FI
FO01844	B1844F6	C-SF232M



		LODI
FO01836	B1836F6	C-SF244
FO01827	B1827F6	C-SF3.0L
FO01735	B1735F6	C-SF3.8C
FO01751	B1751F6	C-SF3.8L
FO01854	B1854F6	C-SF300E
FO01747	B1747F8	C-SF302FI
FO01717	B1717F8	C-SF351FI
FO019132	B19132F6	C-SF4.0
FO01950	B1950F6	C-SF4.2
FO01716	B1716F8	C-SF4.6LFI
FO01706	B1706F8	C-SF400E
FO01744	B1744F8	C-SF5.0LFI
GM01203	B1203G4	C-SG1.8
GM019163	B19163G6	C-SG173E
GM019255	B19255G6	C-SG173ZF
GM01203	B1203G4	C-SG2.5
GM01740	B1740G6	C-SG2.8P
GM01726	B1726G6	C-SG231
GM01710	B1710G6	C-SG250E
GM01545	B1545G6	C-SG250N
GM01719	B1719G6	C-SG3.1
GM01741	B1741G6	C-SG3.1S
GM01952	B1952G6	C-SG3.8
GM01720	B1720G8	C-SG350E
GM01731	B1731G8	C-SG350ELR
GM019261	B19261G8	C-SG350ELR

		LODI
GM019261	B19261G8	C-SG350ER
GM01544	B1544G8	C-SG350LTBI
GM01989	B1989G8	C-SG350LTBIR
GM01756	B1756G8	C-SG350TBI
GM01810	B1810G8	C-SG350TBIR
GM019257	B19257G6	C-SG4.3
GM01956	B1956G8	C-SG454E
GM01928	B1928G8	C-SG5.7
GM01953	B1953G8	C-SG5.9
GM01917	B1917G8	C-SG7.4
NI01221	B1221N8	C-SN2.0D
FG01813	B1813FG8	C-SU8E
VW056	B6355W4	C-VW01
VW064	B6936W4	C-VW02
VW062	B6934W4	C-VW03
VW056	B6355W4	C-VW04
VW057	B6356W4	C-VW05
VW042	B6945W6	C-VW06
VW077	B69223W4	C-VW07
VW053	B6351W4	C-VW09
VW054	B6352W4	C-VW10
VW061	B6933W4	C-VW11
VW055	B6353W4	C-VW12
VW050	B6962W4	C-VW13
VW071	B69149W4	C-VW15
FO0143	B5974F6	C-EF3.0

## CAHSA vs STANDARD

		STANDARD
FO0138	B6951F6	209
TY027	B69162Y4	5405
TY047	B69252Y4	5405
TY011	B6932Y4	5408
TY023	B69143Y4	5409
TY039	B69253Y4	5410
TY010	B6931Y2	5412
TY060	B69363Y4	5413
TY059	B69362Y4	5414
TY062	B69290Y4	5417
TY061	B69364Y4	5418
TY021	B69116Y6	5601
TY022	B69119Y6	5605
FO099	B6746F4	6444
FO013	B6780F4	6444
GM0238	B69254G4	6447
NI031	B6231N8	6454
NI073	B69153N4	6454
FO0107	B6852F4	6457
FO099	B6746F4	6458
FO013	B6780F4	6458
FO060	B6880F4	6458
FO050	B6202F4	6459
FO0123	B6714F4	6459
FO0126	B6761F4	6459
FO0130	B6833F4	6459
FO059	B6737F4	6460
FO087	B6815F8	6461
FO087	B6815F8	6462
FO0127	B6826F4	6463
FO059	B6737F4	6464
FO094	B6913F4	6465
FO092	B6912F4	6466
FO087	B6815F8	6467
GM019	B6740G6	6627
GM0198	B69163G6	6627
TY017	B6812Y6	6636
GM0200	B69164G6	6637
FO0105	B6844F6	6638
FO061	B6601F6	6639
FO0129	B6831F6	6639
GM056	B6764G6	6640
FO062	B6707F6	6643
FO0113	B6858F6	6643
FO0138	B6951F6	6643
FO0105	B6844F6	6646

		STANDARD
GM062	B6719G6	6649
GM064	B6726G6	6652
GM0154	B6968G6	6653
GM0110	B6856G6	6656
GM0110	B6856G6	6657
FO0182	B69138F6	6658
FO097	B6708F6	6659
FO061	B6601F6	6660
FO0129	B6831F6	6660
FO0113	B6858F6	6662
FO0101	B6836F6	6663
FO066	B6735F6	6664
GM0108	B6851G6	6668
GM064	B6726G6	6669
FO063	B6718F6	6670
FO0162	B69106F6	6670
FO079	B6751F6	6671
FO066	B6735F6	6673
FO065	B6734F6	6674
FO0144	B6974F6	6675
FO0168	B69125F6	6675
FO0187	B69168F6	6675
FO0187	B69168F6	6676
FO0150	B6977F6	6677
FO0142	B6973F6	6678
FO079	B6751F6	6683
FO0146	B6975F6	6684
FO0189	B69169F6	6685
FO0176	B69132F6	6686
FO0191	B69170F6	6687
FO0199	B69235F6	6689
FO0168	B69125F6	6690
FO0148	B6976F6	6691
FO0164	B69112F6	6692
FO0158	B6992F6	6693
GM087	B6835G8	6868
GM0144	B6956G8	6870
GM0102	B6837G8	6874
FO075	B6763F8	6879
ES009	B6813FG8	6880
GM0144	B6956G8	6883
GM099	B6544G8	6885
GM0160	B6989G8	6885
GM099	B6544G8	6889
FO077	B6769F8	6897
ES009	B6813FG8	6898

		STANDARD
FO077	B6769F8	6900
FO0111	B6855F8	6903
GM021	B6720G8	6907
GM0102	B6837G8	6908
FO073	B6739F8	6911
FO076	B6716F8	6914
FO0152	B6978F8	6915
FO0152	B6978F8	6916
FO072	B6728F8	6918
CH0101	B69173C10	6919
CH099	B69174C10	6922
FO098	B6717F8	6923
FO070	B6725F8	6926
FO072	B6728F8	6928
GM039	B6731G8	6930
SU002	B69177SU3	7303
TY015	B6723Y4	7413
MZ012	B6818MZ4	7413
NI010	B6400N4	7414
NI028	B6402N4	7414
GM061	B6203G4	7416
GM0208	B69175G4	7419
NI022	B6221N8	7421
GM0192	B69152G4	7426
TY026	B69158Y4	7429
GM0192	B69152G4	7431
GM0172	B6998G4	7432
GM0130	B6282G4	7434
GM0132	B6828G4	7434
TY026	B69158Y4	7436
MI018	B69179MI4	7438
GM0210	B69176G4	7440
GM085	B6830G4	7443
TY030	B69181Y4	7446
CH058	B6849C4	7450
CH060	B6857C4	7450
MI010	B69120M4	7450
MZ012	B6818MZ4	7452
MZ016	B6793MZ4	7453
CH068	B6543C4	7454
NI035	B6233N4	7456
MZ011	B6817MZ4	7457
SU004	B69178SU4	7459
HN014	B69182HN4	7470
CH068	B6543C4	7473
CH035	B6712C4	7473

\*Importante: La información indicada en esta publicación, ha sido obtenida por fuentes confiables y oficiales, consideramos que es correcta, sin embargo no asumimos ninguna responsabilidad por errores, cambios, omisiones o datos que resultaron de estos\*.

NI022	B6221N8	7477
GM0180	B69126G4	7478
MI006	B6781M4	7479
CH073	B6753C4	7484
MZ020	B6909MZ4	7486
FO0132	B6948F4	7486
GM0123	B6713G4	7492
MZ022	B69183MZ4	7494
GM0202	B69165G4	7495
GM024	B6742G4	7496
GM0119	B6929G4	7496
CH053	B6907C4	7497
NI025	B6531N4	7502
NI059	B6788N4	7502
NI036	B6530N4	7503
NI052	B6982N4	7505
CH027	B6333C4	7507
MI020	B69180MI4	7508
CH092	B69124C4	7510
GM0204	B69166G4	7511
MZ024	B69184MZ4	7512
MI010	B69120M4	7515
HN003	B6979HN4	7517
HN008	B6814HN4	7523
CH029	B6334C4	7526
GM0158	B6972G4	7527
SZ010	B69185SZ4	7528
MZ020	B6909MZ4	7537
FO0126	B6761F4	7541
GM0119	B6929G4	7542
GM0194	B69159G4	7543
FO0195	B69172F4	7543
HY008	B6774HY4	7544
KI006	B69187K4	7547
GM0212	B69186G4	7548
MZ017	B6794MZ4	7551
NI067	B69100N4	7555
VW050	B6962W4	7558
DW007	B6204D4	7567
GM0206	B69167G4	7568
GM0196	B69161G4	7569
CH064	B6965C4	7570
NI067	B69100N4	7576
CH089	B69107C4	7581

IS019188	B19188I4	7583
GM0106	B6850G6	7616
GM023	B6741G6	7622
GM0154	B6968G6	7624
CH070	B6821C6	7625
MI012	B69121M6	7625
GM084	B6829G6	7626
MZ026	B69233MZ6	7627
CH056	B6842C6	7629
MI012	B69121M6	7629
TY018	B6822Y6	7631
NI064	B6536N6	7643
GM01846	B1846G6	7645
CH085	B6987C6	7648
CH019	B6791C6	7649
CH067	B6970C6	7650
GM01952	B1952G6	7658
NI069	B69114N6	7663
FO0170	B69129F6	7663
CH038	B6743C6	7664
GM062	B6719G6	7667
GM084	B6829G6	7667
NI071	B69115N6	7669
CH097	B69160C6	7670
GM01994	B1994G6	7671
GM01993	B1993G6	7672
GM01941	B1941G6	7673
GM01971	B1971G6	7673
CH071	B6825C6	7681
GM0131	B6283G6	7687
GM0186	B69137G6	7688
MZ028	B69232MZ6	7692
GM01971	B1971G6	7694
GM01952	B1952G6	7695
HN007	B6981HN6	7697
CH054	B6908C6	7703
CH081	B6985C6	7703
CH071	B6825C6	7704
VW042	B6945W6	7713
GM098	B6917G8	7832
CH011	B6790C8	7834
GM0214	B69189G8	7846
GM01957	B1957G8	7847
GM0170	B6997G8	7849

GM0214	B69189G8	7850
CH079	B6983C8	7851
GM039	B6731G8	7853
GM039	B6731G8	7854
GM01928	B1928G8	7861
GM01954	B1954G8	7861
GM01996	B1996G8	7863
GM01961	B1961G8	7864
GM01997	B1997G8	7864
CH044	B6782C8	7867
GM01954	B1954G8	7874
CH079	B6983C8	7876
GM01961	B1961G8	8749
DH002	B6803DH4	9301
CH087	B6988C4	9475
NI022	B6221N8	9480
CH075	B6824C4	9489
CH058	B6849C4	9489
RE021	B6768R4	9493
RE021	B6768R4	9494
HN011	B69117HN4	9496
RE024	B6380R4	9502
HN011	B69117HN4	9508
VW060	B6795W4	9510
VW056	B6355W4	9513
VW060	B6795W4	9513
VW068	B6969W4	9513
GM0182	B69127G4	9519
VW039	B6357W5	9526
VW037	B6354W4	9533
VA006	B6250V6	9630
CH062	B6841C6	9643
CH085	B6987C6	9644
CH037	B6736C6	9650
VW042	B6945W6	9654
CH011	B6790C8	9826
TY012	B6535Y4	JH-148
MI040	B69372MI4	5416
FO0164	B69112F6	6696
GM01917	B1917G8	7862

\* La información indicada en esta publicación, ha sido obtenida por fuentes confiables y oficiales, consideramos cualquier discrepancia o cambio en esta información de esta publicación.

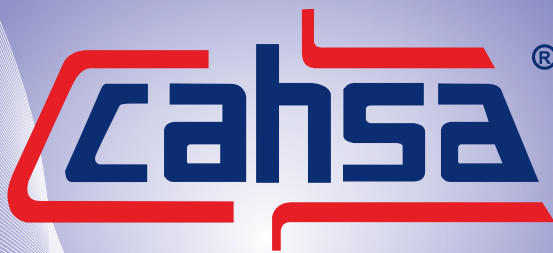

## Cables de control de mando y Cables para bujías.

### NUESTROS PRODUCTOS DE MAYOR VENTA

MODELO	AÑO	MOTOR	CIL	CLAVE
ATOS	01-07	1.0L, 1.1L	4	HY006
ATTITUDE	07-08	1.4L	4	CH0107
H100	04-12	2.4L (GASOLINA) MEXICO	4	HY009
VERNA	04-06	1.5L, 1.6L	4	HY012
GRAND CHEROKEE	04-06	1.6L DOHC 16V	4	CH0107
AVEO	05-07	5.7L HEMI	8	CH019236
CHEVY (VAGONETA, MONZA, POP, JOY, SWING)	04-08	1.6L	4	GM0206
CHEVY C2	95-03	1.4L, 1.6L	4	GM060
CHEVY PICK UP	04-07	1.6L	4	GM089
MATIZ	99-03	1.6L	4	GM060
D21 PICK UP	04-07	1.0L	4	DW017
D22 PICK UP	93-02	D22 2400cc 12V USA	4	NI077
TIIDA	90-97	2.4L S, KA24E, Z24	4	NI035
	93-02	2400cc 12V MEXICO	4	NI019276
	07-12	1.8L	4	NI079
	97-07	1.6L GA16DNE 16V (III)	4	NI060
TSURU III	94-97	1.6L GA16DE 16V (III)	4	NI025
	92-94	1.6L (III) EXCEPTO 8 Y 16 VAL	4	NI037
URVAN	00-07	2.4L 16 VALV KA24DE	4	NI067
	00-07	2.4L TWIN CAM	4	NI050
	01-06	2.5L (5 CABLES)	5	VW073
EUROVAN	92-98	2.5L E, C, D, (6 CABLES)	5	VW039
	97-02	2.8L H, VR6	6	VW042
POINTER	05-07	1.8L (4 CABLES)	4	VW071
	98-05	1.8L (5 CABLES)	4	VW064

**ORGULLOSAMENTE MEXICANOS**



pedidos@enejh.com





# TABLA COMPARATIVA DE LAS APLICACIONES MÁS VENDIDAS



DESCRIPCIÓN	AÑO	HY-POWER	CAHSA	BOSCH	GARLO	LANCER KEM	LODI	OMZ/BERU	STANDARD
NEON, STRATUS	96-00	B1333C4	CH01333		SHY-183	CB-156	C-S7D2.4		
NEON, STRATUS	95-00	B1334C4	CH01334		SHY-179	CB-142/CB-213	C-S7D2.0		
LeBARON, RAM CHARGER	75-92	B1790C8	CH01790		SHY-111	CB-105	C-S7D360		
DODGE RAM PICK UP,	92-AD	B1791C6	CH01791		SHY-259	CB-139	C-SD3.9L		
CHARGER, DURANGO	05-07	B19236C8	CH019236	0986MG0637	SEL-3216				
ATTITUDE, VERNA	05-11	B19304C4	CH019304		SHY-286	CB-269		302HY4/BE1202cHY4	
DART, VOLARE	76-82	B6300C6	CH009	NO APLICA	8HY-135	L-3108		920C6	
CAMION Y CAMIONETA DODGE, F. INJ.	72-92	B6343C4	CH072						
NEW YORKER, CARAVAN	82-90	B6543C4	CH068		8HY-142		C-PD2.5L	843C4/BE1243aC4	7454/7473
DURANGO, RAM 2500	93-00	B6703C8	CH040		8HY-161		C-PD360FI	870C8/1270aC8	
SPIRIT, SHADOW	91-95	B6712C4	CH035		8HY-158	L-3085			7473
VOYAGER	90-95	B6736C6	CH037		8HY-180		C-P7D3.3L	818C6/BE1218aC6	9650
DART "K"	82-91	B6750C4	CH008				C-PD2.2	940C4	
STRATUS, GALANT	95-05	B6825C6	CH071	0986MG0609	8HY-3204	L-3218	C-P7D2.5	802C6	7681/7704
CARAVAN, VOYAGER	87-89	B6841C6	CH062		8HY-251		C-PD3.0		9643
SPIRIT, SHADOW	88-96	B6842C6	CH056		8HY-252	L-3107			7629
CHEROKEE, LAREDO,	87-99	B6908C6	CH054	0986MG0611	8HY-2616 / 2608	L-3320 , L-3083	C-P7D4.0N	804C6/BE1204aC6	7703
T&C, CARAVAN, VOYAGER	96-00	B69160C6	CH097		8HY-3207		C-P7D3.8L	819C6	7670
PT-CRUISER, STRATUS, CARAVAN, VOYAGER	01-04	B6965C4	CH064	0986MG0612 0986MG0630 0986MG0718	HY-3210	L-3135	C-P7D2.4L	810C4, 861C4/BE 1210aC4, BE 1261aC4	7570
PICK UP RAM 3500	01-02	B6983C8	CH079		8HY-261	L-3303	C-PD360TBI, C- P7DDAKOTA	872C8	7851/7876
T&C, CARAVAN, VOYAGER	01-05	B6985C6	CH081		8HY-3211	L-3221 , L3306	C-P7D3.8	806C6/BE1206aC6/ BE1241aC6	7703
MATIZ, SPARK	06-08	B19104D4	DW019104		SHY-271	CB-274			
F PICK UPS, E VANS	84-92	B1717F8	FO01717		SEL-2965	CB-226, CB-290	C-SF351FI		
ESCORT XL, VAGONETA	94-02	B1737F4	FO01737		SEL-173, SEL-3333	CB-174	C-SF2.0L		
RANGER, EXPLORER	89-00	B1815F8	FO01815		SEL-187	CB-191	C-SU8E		
FOCUS ZTS, MISTIQUE	99-02	B1913F4	FO01913		SEL-3335	CB-219	C-SF2.0		
FIESTA IKON KA	01-08	B1937F4	FO01937		SEL-240	CB-238, CB-264			
EXPLORER, EXPEDITION	97-02	B6100F8	FO095	0986MG1003	1003	CH04	CA004		
COUGAR, THUNDERBIRD	77-94	B6700F6	FO014		8HY-152		C-PF171	950F6 / BE1250aF6	
GRAN MARQUIS, CROWN VICTORIA	66-84	B6200F8	FO010		8HY-106		C-P7F302, C-PF302		
FORD F400 "V8" 4.0L, G.6L	92-97	B6706F8	FO0122		8HY-140	L-6307	C-PF400E		
FORD CAMIONETAS		B6707F6	FO062						6643
C. VICTORIA, TOWN CAR	92-96	B6716F8	FO076	0986MG0439	8HY-165, 2993	L-6301	C-PF400E	819F8/839F8 / BE1239aF8	6914
EXPLORER XLT, MOUNTAINNER	96-01	B6725F8	FO070		8HY-3328, 3329	L-6302 , L-6315	C-PF5.0LFI	861F8/BE1261aF8	6926
AEROSTAR	91-97	B6734F6	FO065	0986MG0428	8HY-3319	L-6233		BE 1262aF6	6674
MICROBUS FORD	92-94	B6747F8	FO0116				C-PF302FI		
WINDSTAR, MUSTANG	94-02	B6751F6	FO079	0986MG0425 0986MG0430	8HY-3320/3344	L-6231, L-6245	C-PF3.8L, C-PF3.8N	817F6/BE 1217aF6	6671/6683
MICROBUS FUEL INJ	92-95	B6769F8	FO077		8HY-2972				6897/6900
CONTOUR, MYSTIQUE	95-99	B6826F4	FO0127	0986MG0431	8HY-176	L-6185	C-PF2.0M	815F4	6463
RANGER, BRONCO II	84-92	B6827F6	FO0128	0986MG0432 0986MG0445 0986MG0472	8HY-2961		C-PF2.9, C-PF3.0L	516aF6	
PICK UP RANGER	82-90	B6833F4	FO0130		8HY-208		C-PF2.3L		6459
RANGER, EXPLORER, AEROSTAR	90-99	B6836F6	FO0101	0986MG0433	8HY-177	L-6240 , L-6232 , L-6252	C-PF244		6663

\*Importante: La información indicada en esta publicación, ha sido obtenida por fuentes confiables y oficiales, consideramos que es correcta, sin embargo no asumimos ninguna responsabilidad por errores, cambios, omisiones o daños que resultaran de estos".

DESCRIPCIÓN	AÑO	HY-POWER	CAHSA	BOSCH	GARLO	LANCER KEM	LODI	OMZ/BERU	STANDARD
SERIES E y F, BRONCO	89-97	B6858F6	FO0113		8HY-166	L-6234			6643/6662
EXPLORER, RANGER	99-02	B69132F6	FO0176		8HY-3349, 3351	L-6236	C-PF4.0		6686
RANGER	01-06	B69135F4	FO0180		8HY-3352	L-6193		814F4/BE1214aF4	
RANGER, SUPER	98-00	B6974F6	FO0144	0986MG0715	8HY-3334, 3343	L-6249	C-PF3.0C		6675
SERIES E Y F LOBO	01-04	B6976F6	FO0148		8HY-3350	L-6242	C-PF4.2L	819F6, BE1219aF6	6691
PICK UP LOBO	97-00	B6977F6	FO0150		8HY-3332	L-6248			6677
G. MARQUIS, TOWN CAR	96-04	B6978F8	FO0152		8HY-263	L-6304, L-6305		803F8/1203aF8	6915/6916
WINDSTAR, MUSTANG	01-04	B6992F6	FO0158		8HY-3348	L-6246	C-PF3.8		6693
FORD Y G.M. UNIV (780019)		B6760FG8	ES011						
FORD Y G. M. UNIV. (78020) LARGO		B6770FG8	ES012		8HY-214				
FORD Y G. M. UNIV LARGO DOBLE BOBINA		B6813FG8	ES009		8HY-150		C-PG350TBIR	808F8	6880/6898
CELEBRITY (1era GEN)	85-93	B1719G6	GM01719		SHY-168	CB-114	C-SG3.1		
CAPRICE, IMPALA	76-84	B1720G8	GM01720		SEL-132	CB-112	C-SG350E		
MICROBUS BOB EXT	92-96	B1731G8	GM01731		SEL-3114	CB-130	C-SG350EL		
CELEBRITY, (2a GEN)	93-96	B1741G6	GM01741		SHY-151	CB-110	C-SG3.1S		
CHEVY C2, CORSA, MERIVA, TORNADO	02-08	B1911G4	GM01911		SHY-170	CB-247	C-S7GCHEVY		
SERIES E, C, G, K y S	96-02	B1917G8	GM01917	0986MG0729	SEL-3137	CB-211	C-SG7.4	320G8 / BE800V8 G8	7862
EXPRESS VAN, IMPALA	07-12	B19219G8	GM019219		SEL-3160, 3162	CB-294	C-S7G8.1N		
HEAVY DUTY, G30 VAN	01-08	B1928G8	GM01928	0986MG0728	SEL-3138		C-SG5.7	305G8	7861
MALIBU, CENTURY, LUMINA, VENTURE, CUTLASS, SILHOUETTE, GRAND AM	96-01	B1952G6	GM01952	0986MG0727 0986MG0740 0986MG0961 0986MG0964	SEL-3155	CB-216, CB-250, CB-257	C-SG3.8		7658/7695
S & T (S10), C. BLAZER	91-93	B6283G6	GM0131		8HY-3150				7687
MICROBUS, C-20	86-91	B6534G8	GM059	0986MG0954		L-4345		855G8/BE 1255aG8	
SUBURBAN, SILVERADO Y MICROBUS	92-AD	B6544G8	GM099	0986MG0916 0986MG0957 0986MG0723	8HY-157		C-PG350LTBI	844G8	6885/6889
CAVALIER	95 - AD	B6709G4	GM066					854G4/BE 1254aG4	
BLAZER	85-89	B6715G6	GM0100	0986MG0932	8HY-219		C-PG2.8		
CHEVY, CORSA	94-98	B6729G4	GM060	0986MG0912	8HY-270	L-4145		838G4	
MICROBUS, C10, C15, C30	87-91	B6730G8	GM022	0986MG0955				932G8/BE1232aG8	
CENTURY, CITATION	82-86	B6740G6	GM019		8HY-141		C-PG2.8P	933G6	6627
CAVALIER, PICK UP, S-10, BLAZER	95-AD	B6742G4	GM024		8HY-169		C-PG2.2	BE 1213aG4	7496
SUBURBAN, SILVERADO	92-AD	B6756G8	GM0121				C-PG350TBI		
PICK UP S10, HOMBRE	95-97	B6828G4	GM0132	0986MG0941 0986MG0948	8HY-3111, 3139			BE 1221aG4	7434
BLAZER, JIMMY	85-95	B6829G6	GM084		8HY-189	L-4230	C-PG3.1T	BE 1208aG6	7626/7667
PICK UP BLAZER, ASTRO	88-93	B6830G4	GM085	0986MG0944	8HY-3156		C-PG2.5N		7443
CHEYENNE	93-02	B6915G8	GM094			L-4339			
AVEO, G3	04-08	B69167G4	GM0206		8HY-4407		C-P7GAVEO	860G4, BE 1260aG4	7568
C1500/K1500, P35/P3500 VAN	96-98	B6916G6	GM096	0986MG0722		L-4215		803G6, 853G6, / BE1253aG6, 807G6/BE 1207aG6	
PICK UP LUV	98-04	B6927G4	GM0120	0986MG0951	8HY-228/247	L-4146	C-P7G1.8C	823G4/BE1223aG4	
CAVALIER, SUNFIRE	98-02	B6929G4	GM0119		8HY-3143	L-4322	C-PG2.2C	BE1220aG4	7496/7542
SILVERADO, BLAZER	98-04	B6941G6	GM0134		8HY-3125/3154		C-PG4.3L		
KODIAK, SILVERADO	93-03	B6954G8	GM0140		8HY-3152	L-4341	C-PG8.1		
ASTROVAN, SAFARI VAN	88-91	B6968G6	GM0154		8HY-215, HY-3102		C-PG4.3A		6653/7624
S10/T10 BLAZER	96-00	B6971G6	GM0156		8HY-3146	L-4236, L-4274			
ATOS	01-08	B1779HY4	HY01779		SHY-239	CB-215	C-S7D1.0		
VERNA	04-06	B19102HY4	HY019102		SEL-275, SEL-276			303HY4/BE1203cHY4	
H100	04-12	B6778HY4	HY009		8HY-265			804HY4, BE1201aHY4	
THIDA, X-TRAIL, MICRA	07-14	B6118N4	NI079						
D21, PICK UP	89-04	B1233N4	NI01233	0986MG0725	SHY-155, 238, 4693	CB-149	C-S7N2.4F	BE1207cN4	
HIKARI, SAMURA	84-92	B1400N4	NI01400		SHY-156	CB-116	C-S7N1600III		
SENTRA GST-GSX	95-00	B1531N4	NI01531	0986MG0703	SHY-185	CB-145	C-S7N16V	303N4/BE 1203cN4	
URVAN	00-07	B1537N4	NI01537			CB-242		301N4, BE 1201cN4	
XTERRA, URVAN	98-07	B19100N4	NI019100		SHY-4696	CB-249	C-S7N2.4U		
PATHFINDER, FRONTIER	97-04	B19115N6	NI019115	0986MG0726	SHY-6076	CB-203		1202cN6	
D-21, D22	05-08	B19276N4	NI019276		SEL-4697	CB-293			
DATSUN Y CAMIONETAS	63-84	B6220N4	NI034		HY-120		C-PN1500		
200SX, 720 PICK UP	80-89	B6221N8	NI022		HY-213	L-2113	C-PN2.0D		7421/7477/9480

\* caso de variaciones en precios o características, consulte con el representante. La información indicada en esta publicación ha sido obtenida por fuentes confiables y oficiales. Consideramos en cualquier caso que se debe verificar la información antes de tomar cualquier decisión de compra.



\*Importante: La información indicada en esta publicación, ha sido obtenida por fuentes confiables y oficiales, consideramos que es correcta, sin embargo no asumimos ninguna responsabilidad por errores, cambios, omisiones o datos que resultaran de estos.\*

DESCRIPCIÓN	AÑO	HY-POWER	CAHSA	BOSCH	GARLO	LANCER KEM	LODI	OMZ/BERU	STANDARD
NISSAN 2000, 720 PICK UP	68-80	B6224N4	NI062		HY-202		C-P7N2.0L, C-PN2.0L, C-P7N2.0S, C-PN2.0S		
ICHIVAN, SAKURA, PICK UP	81-92	B6230N4	NI009		8HY-134				
D21, PATHFINDER	86-90	B6231N8	NI031		8HY-220		C-PNZ24		6454
TSURU I	1983	B6390N4	NI063				C-P7N1600, C-PN1600		
TSURU	93-	B6402N4	NI028		8HY-171	L-2106	C-PN1600EO		7414
TSURU II Y III	84-92	B6500N4	NI008			L-2105	C-PN1800	923T4	
LUCINO GSR, 16V, SENTRA GSS	90-00	B6530N4	NI036		8HY-186	L-2101 (7)			7503
TSUBAME, TSURU III	94-07	B6533N4	NI060		8HY-244				
TSURU III	92-94	B6711N4	NI037						
PATHFINDER, PICK UP D21	86-89	B6536N6	NI064			L-2201 (7),			7643
PICK UP D21 12 VALV 2.4L	93-02	B6538N4	NI065						
QUEST XE, GXE	93-98	B69114N6	NI069		HY-3310	L-6150	C-P7N3.0		7663
HI LUX TRUCKS, PICK UP	75-80	B1721Y4	TY01721		SEL-206	CB-244	C-S7TY22R		
4 RUNNER	80-88	B6723Y4	TY015		HY-223		C-PTY22RL		7413
PICK UP, 4 RUNNER	88-97	B6822Y6	TY018		8HY-6257, 6312				7631
TACOMA, T100, 4RUNNER	95-04	B69119Y6	TY022	0986MG0738	5HY-6325			1503Y6, BE1203dY6	5605
4 RUNNER	93-95	B69143Y4	TY023		5HY-4569	L-9029 (5)			5409
UNIVERSAL 4 CIL CONV.		B6310U4	UN026		8HY-112				
UNIVERSAL 8 CIL CONV.		B6330U8	UN028		8HY-130				
SEDAN, COMBI, BRASILIA	63-89	B6340W4	VW012		8HY-115		C-P7W1600		
GOLF, JETTA, ATLANTIC Y CARIBE	76-89	B6360W4	VW013		8HY-137, 4354		C-P7W1600C, C-PW1600C		
GOLF, JETTA, A3	94-00	B6354W4	VW037	0986MG0706	8HY-194	CB-162		5 A3 / 2.0	9533
DERBY	94-07	B6355W4	VW056	0986MG0705	HY-172, 8HY-197			5 DERBY	9513
EUROVAN	00-04	B6357W5	VW039		HY-5010	L-1274, CB-246		EUROVAN	9526
VW SEDAN	90-94	B6745W4	VW058		HY-199				
POLO, LUPO, SPORTVAN	02-07	B69113W4	VW067		HY-264	L-1171, L-1173, CB-278, CB-279, CB-291		POLO 02	
POINTER	04-05	B69149W4	VW071						
EUROVAN NACIONAL	00-03	B69154W5	VW073		HY-246				
SEDAN	94-	B6933W4	VW061		8HY-192	CB-172			
GOLF, JETTA	93-99	B6934W4	VW062			CB161		5A2/1.8	
POINTER, PICK UP, VAN	98-05	B6936W4	VW064	0986MG0708	8HY-198	CB-190		POINTER	
GOLF, JETTA	94-02	B6945W6	VW042	0986MG0709	8HY-195	L-1275, CB-254		VR - 6	9654/7713
JETTA, BEETLE	98-03	B6962W4	VW050	0986MG0707	8HY-193, 4395	L-1170, CB-230		NB / A4	7558

**cahsa**®

100% FABRICAMOS TODO TIPO DE CABLES PARA BUJÍAS Y DE CONTROL DE MANDO PARA TODAS LAS MARCAS Y TODOS LOS MODELOS CON LA MEJOR CALIDAD.

MX HECHO EN MEXICO

Hecho por MEXICANOS

# CONECTORES

ENTRE EL CABLE DE ENCENDIDO Y BUJÍAS.



Para la conexión entre el cable de encendido y la bujía hay dos tipos diferentes de contactos:

## SAE Ø 6.3



## M 4

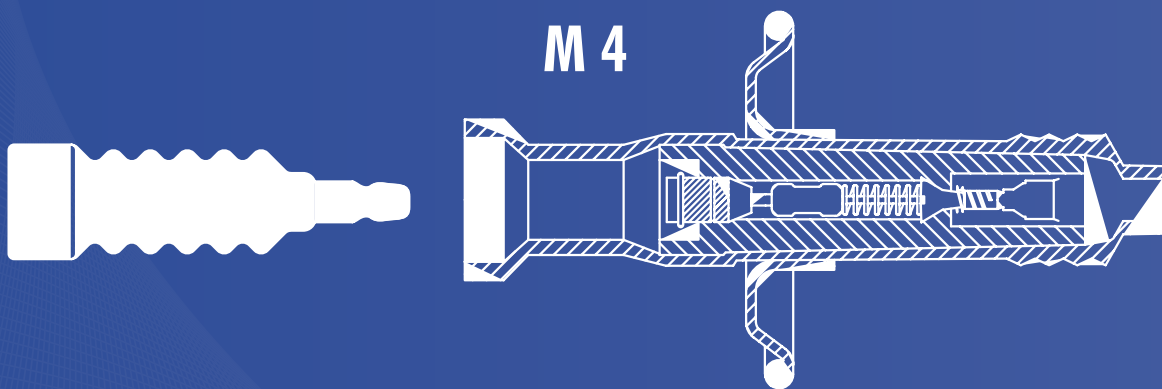

# CONECTORES

ENTRE EL CABLE DE ENCENDIDO Y LA CONEXIÓN DEL DISTRIBUIDOR O BOBINA DE ENCENDIDO.

Para la conexión indicada hay diferentes tipos de contactos:

## DIN Ø 8.2

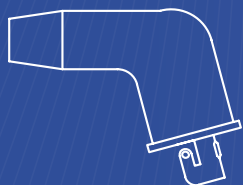

## SAE Ø 6.3

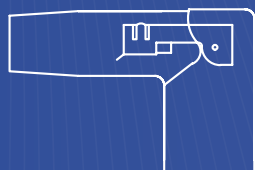

## PIN Ø 4



## PIN Ø 7

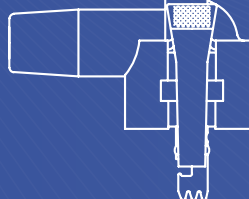

## PIN Ø 5

